



Specification grade HID floodlight with cutting edge design, architectural quality, superior features and mounting options at competitive prices.

Color: Bronze

Weight: 16.2 lbs

Project:	Type:
Prepared By:	Date:

Lamp Info		Ballast Info	
Type:	ED17	Type:	HX-HPF QT
Watts:	70W	120V:	N/A
Shape/Size:	N/A	208V:	N/A
Base:	N/A	240V:	N/A
ANSI:	N/A	277V:	.4/.4A
Hours:	24,000	Input Watts:	91W
Lamp Lumens:	6,400	Efficiency:	77%
Efficacy:	70 LPW		

Technical Specifications

Listings

UL Listing:

Suitable for wet locations. Suitable for ground mounting.

Other

Photocell>:

Button 277V Photocell Included. Photocell is compatible with 208V-277V.

Patents:

Pat. D545,471.

Country of Origin:

Designed by RAB in New Jersey and assembled in the USA by RAB's IBEW Local 3 workers.

Buy American Act Compliant:

This product is a COTS item manufactured in the United States, and is compliant with the Buy American Act.

Recovery Act (ARRA) Compliant:

This product complies with the 52.225-21 "Required Use of American Iron, Steel, and Manufactured Goods-- Buy American Act-- Construction Materials (October 2010).

Trade Agreements Act Compliant:

This product is a COTS item manufactured in the United States, and is compliant with the Trade Agreements Act.

GSA Schedule:

Suitable in accordance with FAR Subpart 25.4.

Construction

Housing:

Precision die cast aluminum. 1/2" NPS locking Swivel Arm, Wall Bracket Trunnion or Slip Fitter.

Reflector:

Anodized aluminum. Field adjustable beam spread. Rotates 90° for horizontal or vertical lamp position.

Lens Frame & Glare Shield:

Precision die cast aluminum. Hinged for easy access. Phillips head screws for added security.

Finish:

Our environmentally friendly polyester powder coatings are formulated for high-durability and long-lasting color, and contains no VOC or toxic heavy metals.

Lens:

Thermal tempered shock resistant glass, 3/16" thick.

Lens Gasket:

High temperature one piece molded silicone set in die cast retaining groove. Remains in place during relamping.

Ground Mounting:

Use the new MPM19 PVC Mighty Post with aluminum cap for sturdy installation.

Electrical

Socket:

HID Porcelain 4kv Pulse Rated socket with nickel plated screw shell CFL Plug in type, GX24q-4 base.

Dimensions

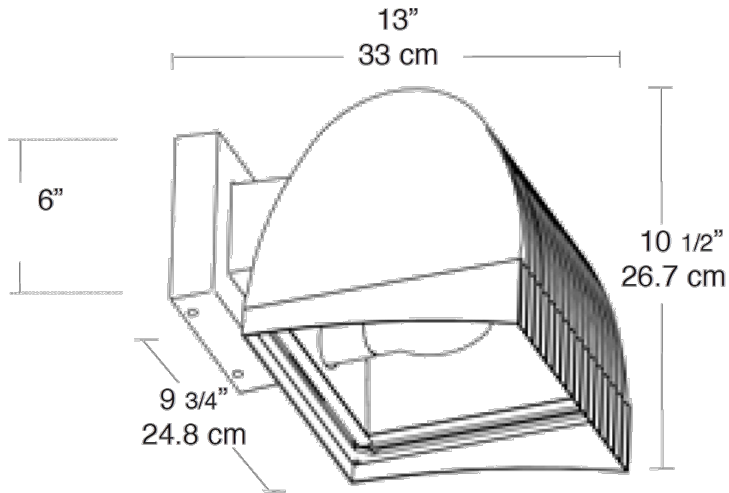

Features

- Integra hood glare shield for friendly lighting when properly aimed
- Silicone gasket for durable weatherproofing & easy relamping
- Precision die cast aluminum housing and lens frame with durable polyester powder coating
- Anodized aluminum reflector rotates for horizontal or vertical lamp position
- Medium base 4kv pulse rated socket
- Two field adjustable socket positions allow fine tuning of beam spread)
- Fins for heat dissipation extend lamp and ballast life