



Small cast aluminum housing with study wall mounting bracket for 13 and 26 Watt or larger size housing for 32 and 42 compact fluorescent. Prismatic globe for low glare and even light distribution. Fixture mounts to junction box or can be wired inside the housing. Wall mounted with 1/2" NPS(or 3/4") side and top conduit feed. Lamp supplied.

Color: Natural

Weight: 4.3 lbs

Project:	Type:
Prepared By:	Date:

Lamp Info		Ballast Info	
Type:	42W Triple	Type:	Elec HPF QT
Watts:	42W	120V:	0.38A
Shape/Size:	N/A	208V:	0.3A
Base:	N/A	240V:	0.2A
ANSI:	N/A	277V:	0.17A
Hours:	12,000	Input Watts:	46W
Lamp Lumens:	3,200	Efficiency:	91%
Efficacy:	70 LPW		

Technical Specifications

Listings

UL Listing:

Suitable for wet locations. Complies with UL Standard 1598 for non-hazardous locations where the lamp, socket and wiring require protection from air, corrosive fumes, non-combustible dusts, moisture, non-explosive vapors and gases. For lamp base up installation only when outdoors.

Construction

Globes:

Clear prismatic, heat resistant glass standard. White glass globes available. Colored and clear unbreakable RAB Permaglobes available for CFL only.

Optional Reflectors:

Highly reflective white baked polyester epoxy powder finish over a heavy gauge aluminum base. Reflectors thread onto fixtures.

Construction:

Die cast aluminum with stainless steel screws.

Guard:

One piece die cast aluminum with set screw.

Hub Size:

3/4" Tapped.

Ballast Minimum Starting Temperature:

0°F.

Electrical

Socket:

HID Glazed porcelain 4kv pulse rated with nickel plated screw shell and spring contacts. CFL White thermo plastic with integral clips for lamp retention.

Other

Country of Origin:

Designed by RAB in New Jersey and assembled in the USA by RAB's IBEW Local 3 workers.

Buy American Act Compliant:

This product is a COTS item manufactured in the United States, and is compliant with the Buy American Act.

Recovery Act (ARRA) Compliant:

This product complies with the 52.225-21 "Required Use of American Iron, Steel, and Manufactured Goods-- Buy American Act-- Construction Materials (October 2010).

Trade Agreements Act Compliant:

This product is a COTS item manufactured in the United States, and is compliant with the Trade Agreements Act.

GSA Schedule:

Suitable in accordance with FAR Subpart 25.4.

Dimensions

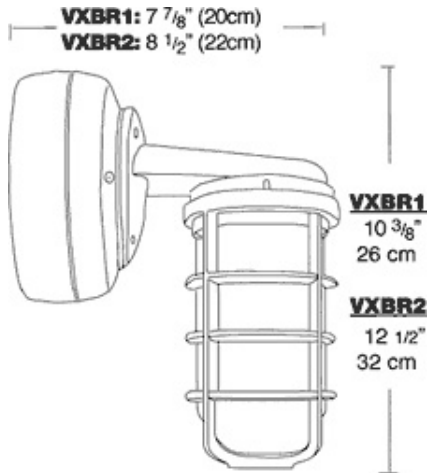

Features

- Weatherproof ballast box
- Die cast aluminum for superior durability
- All stainless steel hardware
- Set screw keeps guard securely in place
- Clear heat resistant prismatic glass globes standard
- Close-up plugs allow Phillips or slotted screwdrivers for easy installation
- High temperature silicone internal gaskets
- Ballast housing mounts to any junction box