



Project:	Type:
Prepared By:	Date:

Driver Info		LED Info	
Type:	Constant Current	Watts:	78W
120V:	0.82A	Color Temp:	3000K
208V:	0.52A	Color Accuracy:	82 CRI
240V:	0.45A	L70 Lifespan:	100000
277V:	0.4A	Lumens:	4,971
Input Watts:	96W	Efficacy:	52 LPW
Efficiency:	81%		

Technical Specifications

Listings

UL Listing:

Suitable for damp locations with cord and hook.
Suitable for wet locations with 3/4" pendant stem.
Covered ceiling mount only.

IESNA LM-79 & LM-80 Testing:

RAB LED luminaires have been tested by an independent laboratory in accordance with IESNA LM-79 and LM-80, and have received the Department of Energy "Lighting Facts" label.

LED Characteristics

LEDs:

Three multi-chip, 26W high-output, long-life LEDs.

Lifespan:

100,000-hour LED lifespan based on IES LM-80 results and TM-21 calculations.

Color Accuracy (CRI):

82 CRI

Correlated Color Temp. (Nominal CCT):

3000K

Color Consistency:

3-step MacAdam Ellipse binning to achieve consistent fixture-to-fixture color.

Color Stability:

LED color temperature is warranted to shift no more than 200K in CCT over a 5 year period.

Color Uniformity:

RAB's range of CCT (Correlated Color Temperature) follows the guidelines of the American National Standard for Specifications for the Chromaticity of Solid State Lighting (SSL) Products, ANSI C78.377.2011.

Electrical

Drivers (3):

Constant Current, 720mA, Class 2 with 6kV surge protection, 100-277VAC, 50/60 Hz.

THD:

12.8% at 120V

Input Watts:

96

Optical

Output Lumens:

4971

Fixture Efficacy:

52

Construction

Ambient Temperature:

AISLED will operate from -40°C (-40°F) to 55°C (131°F).

Thermal Management:

Superior thermal management with external air-flow fins

Housing:

Precision die-cast aluminum housing and door frame with 3-foot 600V power cord.

Mounting:

Heavy-duty 3/4" NPS hook and 3 foot safety chain.

Recommended Mounting Height:

25 ft.

Lens:

Tempered glass.

Reflector:

Specular vacuum metallized polycarbonate. AISLED78 reflector provides superior rectangular distribution pattern specifically designed for aisle lighting.

Gaskets:

High-temperature silicone

Finish:

Our environmentally friendly polyester powder coatings are formulated for high-durability and long-lasting color, and contains no VOC or toxic heavy metals.

Green Technology:

Mercury and UV free. RoHS compliant components. Polyester powder coat finish formulated without the use of VOC or toxic heavy metals.

Other

Equivalency:

AISLED replaces 250 Watt metal halide one-for-one, and is equivalent to 4 lamp T8 fixtures.

California Title 24:

See AISLED78/BL for a 2013 California Title 24 compliant product. Any additional component requirements will be listed in the Title 24 section under technical specifications on the product page.

Technical Specifications (continued)

Other

Patents:

The design of the AISLED™ is protected by patents pending in US, Canada, China, Taiwan and Mexico.

Accessories:

Available accessories include protective polysield and wire guards, replacement lens and doorframe, and an occupancy sensor.

Country of Origin:

Designed by RAB in New Jersey and assembled in the USA by RAB's IBEW Local 3 workers.

Buy American Act Compliant:

This product is a COTS item manufactured in the United States, and is compliant with the Buy American Act.

Recovery Act (ARRA) Compliant:

This product complies with the 52.225-21 "Required Use of American Iron, Steel, and Manufactured Goods-- Buy American Act-- Construction Materials (October 2010).

Trade Agreements Act Compliant:

This product is a COTS item manufactured in the United States, and is compliant with the Trade Agreements Act.

GSA Schedule:

Suitable in accordance with FAR Subpart 25.4.

Dimensions

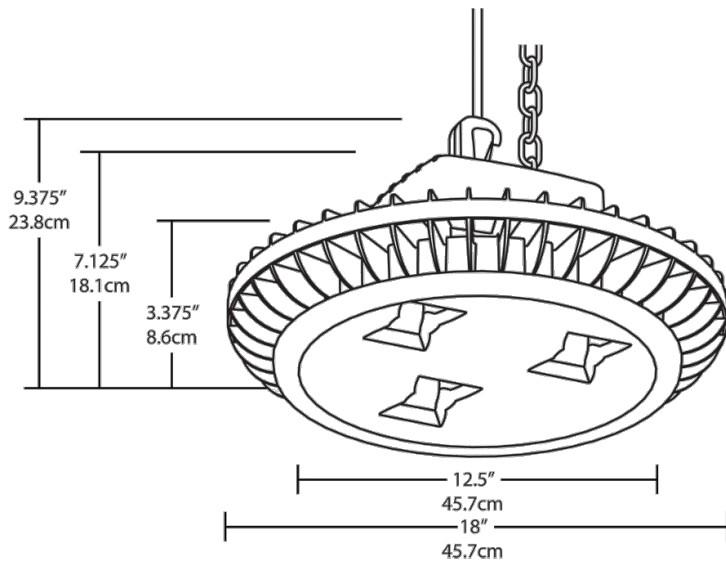

Features

- Efficient, aisle-shaped, vertical illumination
- Eliminates hot spots on higher shelves that can cause glare, improving overall visibility
- 100,000-hour LED lifespan
- 5-year warranty

Ordering Matrix

Family	Watts	Color Temp	Finish	Bi-Level
AISLED	78 = 78W	Blank = 5000K (Cool) Y = 3000K (Warm) N = 4000K (Neutral)	W = White	Blank = No Bi-Level /BL = Bi-Level