



Color: Black

Weight: 32.0 lbs

Project:	Type:
Prepared By:	Date:

Driver Info		LED Info	
Type:	Constant Current	Watts:	150W
120V:	1.31A	Color Temp:	5000K (Cool)
208V:	N/A	Color Accuracy:	71 CRI
240V:	N/A	L70 Lifespan:	100,000
277V:	N/A	Lumens:	17,834
Input Watts:	153W	Efficacy:	116 LPW
Efficiency:	98%		

Technical Specifications

Electrical

Photocell:

120V Swivel Photocell Included. Photocell is only compatible with 120V.

Driver:

One Driver, Constant Current, Class 2, 2100mA 100-277V, 50-60Hz, Power Factor 99%

Surge Protection:

4kV

Listings

UL Listing:

Suitable for wet locations

IESNA LM-79 & LM-80 Testing:

RAB LED luminaires and LED components have been tested by an independent laboratory in accordance with IESNA LM-79 and LM-80.

LED Characteristics

Lifespan:

100,000-hour LED lifespan based on IES LM-80 results and TM-21 calculations

LEDs:

Multi-chip, high-output, long-life LEDs

Color Consistency:

7-step MacAdam Ellipse binning to achieve consistent fixture-to-fixture color

Color Stability:

LED color temperature is warranted to shift no more than 200K in CCT over a 5 year period

Color Uniformity:

RAB's range of CCT (Correlated Color Temperature) follows the guidelines of the American National Standard for Specifications for the Chromaticity of Solid State Lighting (SSL) Products, ANSI C78.377-2017.

Construction

Effective Projected Area:

EPA = 0.75

Maximum Ambient Temperature:

Suitable for use in 40°C (104°F)

Cold Weather Starting:

Minimum starting temperature is -40°C (-40°F)

Thermal Management:

Superior thermal management with external "Air-Flow" fins

Lens:

Tempered glass lens

Housing:

Die-cast aluminum housing, lens frame and mounting arm

IP Rating:

Ingress Protection rating of IP66 for dust and water

Mounting:

Universal mounting arm compatible for hole spacing patterns from 1" to 5 1/2" center to center. Round Pole Adaptor plate included as a standard. Easy slide and lock to mount fixture with ease. Round pole diameter must be >4" to mount fixtures at 90° orientation.

Reflector:

Specular vacuum-metallized polycarbonate

Gaskets:

High-temperature silicone gaskets

Finish:

Formulated for high-durability and long lasting color

Green Technology:

Mercury and UV-free. RoHS compliant components.

Other

Compatibility:

Compatible with Round Poles with a diameter of 2.5" to 6"

Warranty:

RAB warrants that our LED products will be free from defects in materials and workmanship for a period of five (5) years from the date of delivery to the end user, including coverage of light output, color stability, driver performance and fixture finish. RAB's warranty is subject to all terms and conditions found at

Equivalency:

Equivalent to 400W Metal Halide

Buy American Act Compliance:

RAB values USA manufacturing! Upon request, RAB may be able to manufacture this product to be compliant with the Buy American Act (BAA). Please contact customer service to request a quote for the product to be made BAA compliant.

Technical Specifications (continued)

Optical

BUG Rating:

B2 U0 G2

Dimensions

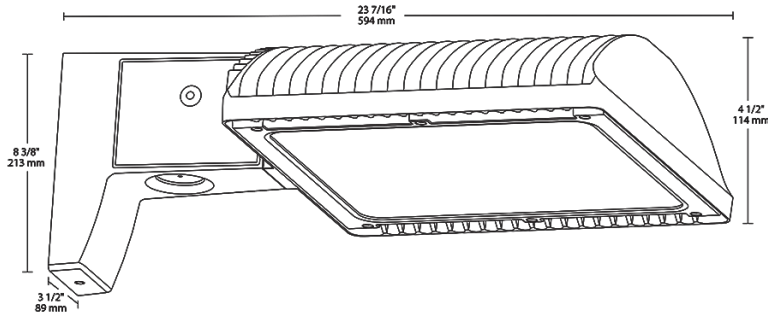

Features

- 66% energy cost savings vs. HID
- 100,000-hour LED lifespan
- 5-year warranty

Ordering Matrix

Family	Optics	Wattage	Mounting	Color Temp	Finish	Driver Options	Options	Other Options
ALED	2T	150	^	^	K	^	/PCS	^
	4T = Type IV	50 = 50W 78 = 78W	Blank = Pole mount SF = Slipfitter	Blank = 5000K (Cool) N = 4000K (Neutral) Y = 3000K (Warm)	Blank = Bronze RG = Roadway Gray W = White K = Black	Blank = 120-277V /480 = 480V /BL = Bi-Level /D10 = 0-10V Dimming	Blank = No Option /LC = Lightcloud® Controller /PCS = 120V Swivel Photocell /PCS2 = 277V Swivel Photocell /PCT = 120-277V Twistlock Photocell /PCS4 = 480V Swivel Photocell /PCT4 = 480V Twistlock Photocell /WS2 = Multi-Level Motion Sensor 20 ft. /WS4 = Multi-Level Motion Sensor 40 ft.	Blank = Standard USA = BAA Compliant
	3T = Type III	105 = 105W 125 = 125W						
	2T = Type II	150 = 150W						