



Specification grade area lights available in IES Type II distributions. For use in parking lots, roadways, pathways and general area lighting. Mounts to 4" square steel poles at 20-35'. 5 Year Warranty.

Color: Gray

Weight: 32.0 lbs

<b>Project:</b>	<b>Type:</b>
<b>Prepared By:</b>	<b>Date:</b>

Driver Info		LED Info	
Type:	Constant Current	Watts:	50W
120V:	N/A	Color Temp:	4000K
208V:	N/A	Color Accuracy:	82 CRI
240V:	N/A	L70 Lifespan:	100000
277V:	N/A	Lumens:	4,386
Input Watts:	55W	Efficacy:	80 LPW
Efficiency:	91%		

## Technical Specifications

### Electrical

#### Photocell:

480V Swivel Photocell Included. Photocell is only compatible with 480V.

#### Driver:

Constant Current, Class 2, 1400mA, 347-480V, 50-60Hz, 0.13A, Power Factor 99%

#### Ballast Volts:

480V

#### Surge Protection:

6kV surge suppression protection tested in accordance with IEEE/ANSI C62.41.2.

### Listings

#### UL Listing:

Suitable for wet locations as a downlight.

#### IESNA LM-79 & IESNA LM-80 Testing:

RAB LED fixtures have been tested by an independent laboratory in accordance with IESNA LM-79 and 80, and have received the Department of Energy "Lighting Facts" label.

### LED Characteristics

#### Lifespan:

100,000-hour LED lifespan based on IES LM-80 results and TM-21 calculations.

#### LEDs:

Multi-chip, high-output, long-life LEDs

#### Color Consistency:

3-step MacAdam Ellipse binning to achieve consistent fixture-to-fixture color.

#### Color Stability:

LED color temperature is warranted to shift no more than 200K in CCT over a 5 year period.

#### Color Uniformity:

RAB's range of CCT (Correlated Color Temperature) follows the guidelines of the American National Standard for Specifications for the Chromaticity of Solid State Lighting (SSL) Products, ANSI C78.377-2011.

### Construction

#### IES Classification:

The Type II distribution is ideal for wide walkways, on ramps and entrance roadways, bike paths and other long and narrow lighting applications. This type is meant for lighting larger areas and usually is located near the roadside. This type of lighting is commonly found on smaller side streets or jogging paths.

#### Effective Projected Area:

EPA = 2.2

#### IP Rating:

Ingress Protection rating of IP66 for dust and water.

#### Ambient Temperature:

Suitable for use in 40°C ambient temperatures.

#### Cold Weather Starting:

The minimum starting temperature is -40°C/-40°F

#### Thermal Management:

Superior patent pending thermal management design with external Air-Flow fins provides maximum operational life, even in high ambient temperature environments.

#### Housing:

Die cast aluminum housing, lens frame and mounting arm.

#### Mounting:

Slipfitter 180° pivot available for mounting on 2 3/8" tenon.

#### Reflector:

Specular vacuum-metallized polycarbonate

#### Gaskets:

High temperature silicone gaskets

#### Finish:

Our environmentally friendly polyester powder coatings are formulated for high-durability and long-lasting color, and contains no VOC or toxic heavy metals.

#### Green Technology:

Mercury and UV free. RoHS compliant components. Polyester powder coat finish formulated without the use of VOC or toxic heavy metals.

### Other

#### Equivalency:

ALED™ 50W replaces 200W metal halide

#### California Title 24:

ALED2T50SF/PCS with the swivel photocell option complies with 2013 California Title 24 building and electrical codes as a commercial outdoor pole-mounted fixture \_\_\_\_\_ ≤75 Watts.

#### Patents:

The ALED™ design is protected by patents pending in the U.S., Canada, China, Taiwan and Mexico.

## Technical Specifications (continued)

### Other

#### Warranty:

RAB warrants that our LED products will be free from defects in materials and workmanship for a period of five (5) years from the date of delivery to the end user, including coverage of light output, color stability, driver performance and fixture finish.

#### Country of Origin:

Designed by RAB in New Jersey and assembled in the USA by RAB's IBEW Local 3 workers.

#### Buy American Act Compliant:

This product is a COTS item manufactured in the United States, and is compliant with the Buy American Act.

#### Recovery Act (ARRA) Compliant:

This product complies with the 52.225-21 "Required Use of American Iron, Steel, and Manufactured Goods-- Buy American Act-- Construction Materials (October 2010).

#### Trade Agreements Act Compliant:

This product is a COTS item manufactured in the United States, and is compliant with the Trade Agreements Act.

#### GSA Schedule:

Suitable in accordance with FAR Subpart 25.4.

### Optical

#### BUG Rating:

B1 U0 G1

### Dimensions

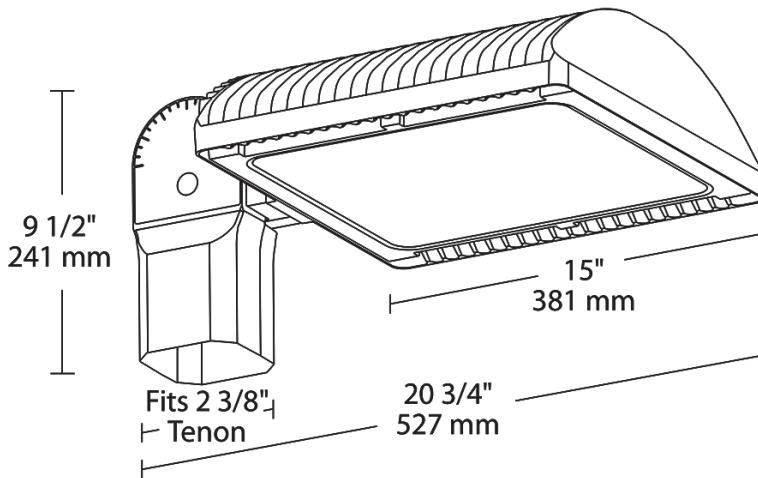

### Features

- 66% energy cost savings vs. HID
- 100,000-hour LED lifespan
- Type II distribution
- 5-year warranty

### Ordering Matrix

Family	Distribution	Watts	Mount	Color Temp	Finish	Voltage	Photocell	Dimming	Sensor	Bi-Level
ALED										
	2T = Type II 3T = Type III 4T = Type IV	50 = 50W	Blank = Arm SF = Slipfitter	Blank = 5000K (Cool) Y = 3000K (Warm) N = 4000K (Neutral)	Blank = Bronze W = White RG = Gray	Blank = 120-277V /480 = 480V	Blank = No Photocell /PC = 120V Button /PC2 = 277V Button /PCS = 120V Swivel /PCS2 = 277V Swivel /PCT = 120-277V Twistlock /PCS4 = 480V Swivel /PCT4 = 480V Twistlock	Blank = No Dimming /D10 = Dimmable	/WS2 = Multi-Level Motion Sensor (Only available for 120-277V with /D10 for 50W)	Blank = No Bi-Level /BL = Bi-Level