



Specification grade area lights available with IES Type III distribution. For use for roadway, general parking and other area lighting applications where a larger pool of lighting is required. Patent pending thermal management system. 5 Year Warranty.

Color: Gray

Weight: 32.0 lbs

Project:

Type:

Prepared By:

Date:

Driver Info

Type:	Constant Current
120V:	1.12A
208V:	0.70A
240V:	0.61A
277V:	0.52A
Input Watts:	133W
Efficiency:	94%

LED Info

Watts:	125W
Color Temp:	4000K
Color Accuracy:	82 CRI
L70 Lifespan:	100000
Lumens:	9,144
Efficacy:	69 LPW

Technical Specifications

Listings

UL Listing:

Suitable for wet locations.

IESNA LM-79 & LM-80 Testing:

RAB LED luminaires have been tested by an independent laboratory in accordance with IESNA LM-79 and LM-80, and have been received the Department of Energy "Lighting Facts" label.

LED Characteristics

Lifespan:

100,000-hour LED lifespan based on IES LM-80 results and TM-21 calculations.

LEDs:

Multi-chip, high-output, long-life LEDs

Color Stability:

LED color temperature is warrantied to shift no more than 200K in CCT over a 5 year period.

Color Uniformity:

RAB's range of CCT (Correlated Color Temperature) follows the guidelines of the American National Standard for Specifications for the Chromaticity of Solid State Lighting (SSL) Products, ANSI C78.377-2011.

Construction

IES Classification:

The Type III distribution is ideal for roadway, general parking and other area lighting applications where a larger pool of lighting is required. It is intended to be located near the side of the area, allowing the light to project outward and fill the area.

Effective Projected Area:

EPA = 2.2

Maximum Ambient Temperature:

Suitable for use in 40°C (104°F) ambient temperatures

Cold Weather Starting:

The minimum starting temperature is -40°C/-40°F

Thermal Management:

Superior thermal management with external Air-Flow fins.

Housing:

Die-cast aluminum housing, lens frame and mounting arm.

Mounting:

Heavy-duty mounting arm with "O" ring seal & stainless steel screws

Reflector:

Specular vacuum-metallized polycarbonate

Gaskets:

High-temperature silicone gaskets

IP Rating:

Ingress Protection rating of IP66 for dust and water.

Finish:

Our environmentally friendly polyester powder coatings are formulated for high-durability and long-lasting color, and contains no VOC or toxic heavy metals.

Green Technology:

Mercury and UV free. RoHS compliant components. Polyester powder coat finish formulated without the use of VOC or toxic heavy metals.

For use on LEED Buildings:

IDA Dark Sky Approval means that this fixture can be used to achieve LEED Credits for Light Pollution Reduction.

Electrical

Drivers:

Two Drivers, Constant Current, Class 2, 1750mA, 100-277V, 50/60Hz, 1.1A, Power Factor 99%

THD:

5.6% at 120V, 16.1% at 277V

Surge Protection:

4kV

Optical

Replacement:

The ALED125 replaces 320W Metal Halide Area Lights.

BUG Rating:

B1 U0 G2

Other

California Title 24:

See ALED3T125SF/D10, ALED3T125SF/BL, ALED3T125SF/PCS, ALED3T125SF/PCS2, or ALED3T125SF/PCT for a 2013 California Title 24 compliant product.

Warranty:

RAB warrants that our LED products will be free from defects in materials and workmanship for a period of five (5) years from the date of delivery to the end user, including coverage of light output, color stability, driver performance and fixture finish.

Technical Specifications (continued)

Other

Country of Origin:

Designed by RAB in New Jersey and assembled in the USA by RAB's IBEW Local 3 workers.

Buy American Act Compliant:

This product is a COTS item manufactured in the United States, and is compliant with the Buy American Act.

Recovery Act (ARRA) Compliant:

This product complies with the 52.225-21 "Required Use of American Iron, Steel, and Manufactured Goods-- Buy American Act-- Construction Materials (October 2010).

Trade Agreements Act Compliant:

This product is a COTS item manufactured in the United States, and is compliant with the Trade Agreements Act.

GSA Schedule:

Suitable in accordance with FAR Subpart 25.4.

Dimensions

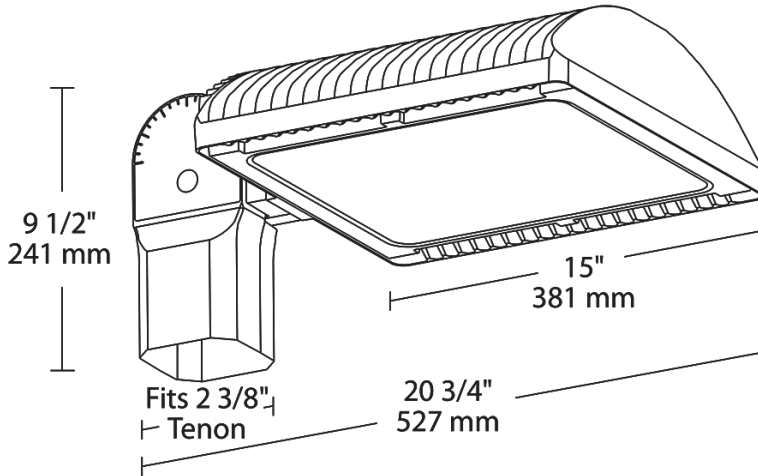

Features

- 66% energy cost savings vs. HID
- 100,000-hour LED lifespan
- Type III distribution
- 5-year warranty

Ordering Matrix

Family	Distribution	Watts	Mount	Color Temp	Finish	Voltage	Photocell	Dimming	Bi-Level
ALED									
	2T = Type II	360 = 360W	Blank = Arm	Blank = 5000K (Cool)	Blank = Bronze	Blank = 120-277V	Blank = No Photocell	Blank = No Dimming	Blank = No Bi-Level
	3T = Type III	260 = 260W	SF = Slipfitter	Y = 3000K (Warm)	W = White	/480 = 480V (Only 360W & 260W)	/PC = 120V Button	/D10 = Dimmable	/BL = Bi-Level
	4T = Type IV	150 = 150W		N = 4000K (Neutral)	RG = Gray		/PC2 = 277V Button		
		125 = 125W					/PCS = 120V Swivel		
		105 = 105W					/PCS2 = 277V Swivel		
		78 = 78W					/PCT = 120-277V Twistlock		
							/PCS4 = 480V Swivel		
							/PCT4 = 480V Twistlock		