



Specification grade area lights available with IES Type IV distribution. Suited for mounting on the sides of buildings and walls, and for illuminating the perimeter of parking areas. Patent pending management system. 5 Year Warranty.

Color: Gray

Weight: 32.0 lbs

Project:

Type:

Prepared By:

Date:

Driver Info

Type:	Constant Current
120V:	N/A
208V:	N/A
240V:	N/A
277V:	N/A
Input Watts:	134W
Efficiency:	93%

LED Info

Watts:	125W
Color Temp:	3000K
Color Accuracy:	83 CRI
L70 Lifespan:	100000
Lumens:	9,674
Efficacy:	72 LPW

Technical Specifications

Electrical

Photocell:

480V Swivel Photocell Included. Photocell is only compatible with 480V.

Drivers:

Two Drivers, Constant Current, Class 2, 1750mA, 347-480V, 50/60Hz, 0.30A, Power Factor 94.2%

THD:

14.1% at 480V

Ballast Volts:

480V

Surge Protection:

4kV

Listings

UL Listing:

Suitable for wet locations.

IESNA LM-79 & LM-80 Testing:

RAB LED luminaires have been tested by an independent laboratory in accordance with IESNA LM-79 and LM-80, and have been received the Department of Energy "Lighting Facts" label.

LED Characteristics

Lifespan:

100,000-hour LED lifespan based on IES LM-80 results and TM-21 calculations.

LEDs:

Multi-chip, high-output, long-life LEDs

Color Stability:

LED color temperature is warranted to shift no more than 200K in CCT over a 5 year period.

Color Uniformity:

RAB's range of CCT (Correlated Color Temperature) follows the guidelines of the American National Standard for Specifications for the Chromaticity of Solid State Lighting (SSL) Products, ANSI C78.377-2011.

Construction

IES Classification:

The Type IV distribution (also known as a Forward Throw) is especially suited for mounting on the sides of buildings and walls, and for illuminating the perimeter of parking areas. It produces a semiCircular distribution with essentially the same candlepower at lateral angles from 90° to 270°.

Effective Projected Area:

EPA = 2.2

Maximum Ambient Temperature:

Suitable for use in 40°C (104°F) ambient temperatures

Cold Weather Starting:

The minimum starting temperature is -40°C/-40°F

Thermal Management:

Superior thermal management with external Air-Flow fins.

Housing:

Die-cast aluminum housing, lens frame and mounting arm.

Mounting:

Heavy-duty mounting arm with "O" ring seal & stainless steel screws

Reflector:

Specular vacuum-metallized polycarbonate

Gaskets:

High-temperature silicone gaskets

IP Rating:

Ingress Protection rating of IP66 for dust and water.

Finish:

Our environmentally friendly polyester powder coatings are formulated for high-durability and long-lasting color, and contains no VOC or toxic heavy metals.

Green Technology:

Mercury and UV free. RoHS compliant components. Polyester powder coat finish formulated without the use of VOC or toxic heavy metals.

For use on LEED Buildings:

IDA Dark Sky Approval means that this fixture can be used to achieve LEED Credits for Light Pollution Reduction.

Optical

Replacement:

The ALED125 replaces 320W Metal Halide Area Lights.

BUG Rating:

B1 U0 G2

Technical Specifications (continued)

Other

California Title 24:

ALED4T125SF/480/PCS4 with the swivel photocell (480V) option complies with 2013 California Title 24 building and electrical codes as a commercial outdoor pole-mounted fixture > 75 Watts at mounting heights greater than 24 feet.

Warranty:

RAB warrants that our LED products will be free from defects in materials and workmanship for a period of five (5) years from the date of delivery to the end user, including coverage of light output, color stability, driver performance and fixture finish.

Country of Origin:

Designed by RAB in New Jersey and assembled in the USA by RAB's IBEW Local 3 workers.

Buy American Act Compliant:

This product is a COTS item manufactured in the United States, and is compliant with the Buy American Act.

Recovery Act (ARRA) Compliant:

This product complies with the 52.225-21 "Required Use of American Iron, Steel, and Manufactured Goods-- Buy American Act-- Construction Materials (October 2010).

Trade Agreements Act Compliant:

This product is a COTS item manufactured in the United States, and is compliant with the Trade Agreements Act.

GSA Schedule:

Suitable in accordance with FAR Subpart 25.4.

Dimensions

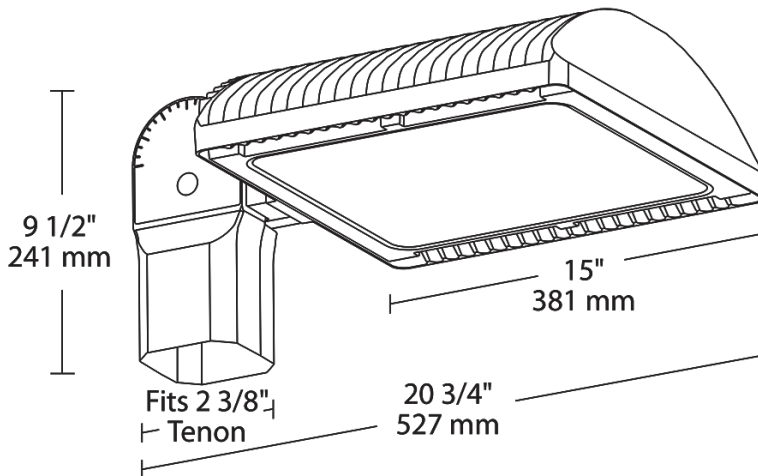

Features

- 66% energy cost savings vs. HID
- 100,000-hour LED lifespan
- Type IV distribution
- 5-year warranty

Ordering Matrix

Family	Distribution	Watts	Mount	Color Temp	Finish	Voltage	Photocell	Dimming	Bi-Level
ALED									
	2T = Type II	360 = 360W	Blank = Arm	Blank = 5000K (Cool)	Blank = Bronze	Blank = 120-277V	Blank = No Photocell	Blank = No Dimming	Blank = No Bi-Level
	3T = Type III	360W	SF = Slipfitter	Y = 3000K (Warm)	W = White	/480 = 480V (Only 360W & 260W)	/PC = 120V Button	/D10 = Dimmable	/BL = Bi-Level
	4T = Type IV	260 = 260W		N = 4000K (Neutral)	RG = Gray		/PC2 = 277V Button		
		150 = 150W					/PCS = 120V Swivel		
		125 = 125W					/PCS2 = 277V Swivel		
		105 = 105W					/PCT = 120-277V Twistlock		
		78 = 78W					/PCS4 = 480V Swivel		
							/PCT4 = 480V Twistlock		