



High output LED pole top area light with IES type V square distribution. Wide and uniform 360 degree pattern ideal for large outdoor areas such as parking lots, corporate parks, and retail settings.

Color: White

Weight: 35.5 lbs

<b>Project:</b>	<b>Type:</b>
<b>Prepared By:</b>	<b>Date:</b>

Driver Info		LED Info	
Type:	Constant Current	Watts:	150W
120V:	1.26A	Color Temp:	3000K
208V:	0.776A	Color Accuracy:	73 CRI
240V:	0.673A	L70 Lifespan:	100000
277V:	0.574A	Lumens:	12,744
Input Watts:	149W	Efficacy:	86 LPW
Efficiency:	N/A		

## Technical Specifications

### Listings

#### UL Listing:

Suitable for wet locations.

#### DLC Listed:

This product is on the Design Lights Consortium (DLC) Qualified Products List and is eligible for rebates from DLC Member Utilities.

DLC Product Code: PXJMUM89

#### Dark Sky Approved:

The International Dark Sky Association has approved this product as a full cutoff, fully shielded luminaire.

#### IESNA LM-79 & LM-80 Testing:

RAB LED luminaires have been tested by an independent laboratory in accordance with IESNA LM-79 and LM-80, and have received the Department of Energy "Lighting Facts" label.

### LED Characteristics

#### LEDs:

Long-life, high-efficiency surface mount LEDs

#### Lifespan:

100,000-hour LED lifespan based on IES LM-80 results and TM-21 calculations.

#### Color Consistency:

7-step MacAdam Ellipse binning to achieve consistent fixture-to-fixture color.

#### Color Stability:

LED color temperature is warrantied to shift no more than 200K in CCT over a 5 year period.

#### Color Uniformity:

RAB's range of CCT (Correlated Color Temperature) follows the guidelines of the American National Standard for Specifications for the Chromaticity of Solid State Lighting (SSL) Products, ANSI C78.377-2011.

### Electrical

#### Driver:

Constant Current, Class 2 with 4kV surge protection, 120-277VAC, 50/60 Hz, 120V: 1.26A, 208V: 0.776A, 240V: 0.673A, 277V: 0.574A

#### THD:

7.1% at 120V, 14.2% at 277V

#### Power Factor:

99.6% at 120V, 92.9% at 277V

#### Dimming Driver:

Driver includes dimming control for 0-10V dimming systems. Requires separate 0-10V DC dimming circuit. Dims as low as 10%.

### Optical

#### BUG Rating:

B4 U1 G3

#### Optics:

Square, Type V distribution

### Construction

#### Cold Weather Starting:

Minimum starting temperature is -40°F / -40°C

#### Maximum Ambient Temperature:

Suitable for use in 40°C (104°F) ambient temperatures

#### Thermal Management:

Superior thermal management with external air-flow fins

### For use on LEED Buildings:

IDA Dark Sky Approval means that this fixture can be used to achieve LEED Credits for Light Pollution Reduction.

#### Effective Projected Area:

EPA = 0.7

#### Housing:

Precision die-cast aluminum

#### Lens:

Clear polycarbonate

#### Reflector:

Vacuum-metalized polycarbonate

#### Gaskets:

High-temperature silicone

#### Mounting:

Tenon for 2 3/8" or 3" OD post or pole-top adaptor

#### Finish:

Our environmentally friendly polyester powder coatings are formulated for high-durability and long-lasting color, and contains no VOC or toxic heavy metals.

## Technical Specifications (continued)

### Construction

#### Green Technology:

Mercury and UV free. RoHS compliant components. Polyester powder coat finish formulated without the use of VOC or toxic heavy metals.

#### Other

#### Replacement:

150 Watt ALED5S replaces 250 Watt Pulse MH / 400 Watt Probe MH.

#### Patents:

The designs of the ALED5S are protected by patents pending in US, Canada, China, Taiwan and Mexico.

#### Country of Origin:

Designed by RAB in New Jersey and assembled in the USA by RAB's IBEW Local 3 workers.

#### Buy American Act Compliant:

This product is a COTS item manufactured in the United States, and is compliant with the Buy American Act.

#### Recovery Act (ARRA) Compliant:

This product complies with the 52.225-21 "Required Use of American Iron, Steel, and Manufactured Goods-- Buy American Act-- Construction Materials (October 2010).

#### Trade Agreements Act Compliant:

This product is a COTS item manufactured in the United States, and is compliant with the Trade Agreements Act.

#### GSA Schedule:

Suitable in accordance with FAR Subpart 25.4.

## Dimensions

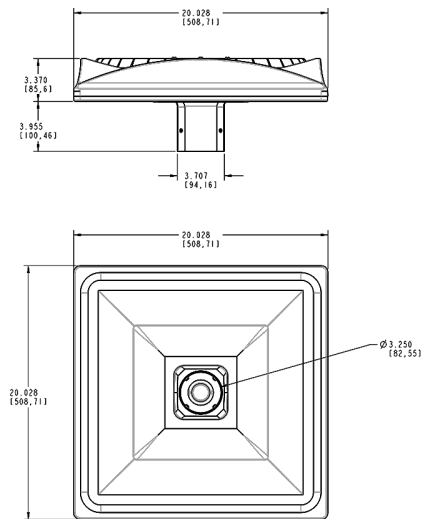

## Features

Precision optics deliver uniform, optimal light distribution

Perfect for parking lots and pathways

100,000-Hour LED lifespan

## Ordering Matrix

Family	Distribution	Shape	Watts	Color Temp	Finish	Voltage	Dimming	Bi-Level	Photocell	Pin	Sensor
ALED	5	S	150	Y	W		/D10			/7PR	
	5 = Type V	S = Square	78 = 78W 150 = 150W	Blank = 5000K (Cool) N = 4000K (Neutral) Y = 3000K (Warm)	Blank = Bronze W = White	Blank = 120-277V /480 = 480V	Blank = No Dimming /D10 = Dimmable	Blank = No Bi-Level /BL = Bi-Level	Blank = No Photocell /PCT = 120-277V Twistlock Photocell	Blank = No Pin /5PR = 5 Pin Receptacle /7PR = 7 Pin Receptacle	Blank = No Sensor /WS2 = Multi-Level Motion Sensor