



High output LED pole top area light with IES type V circular distribution. Wide and uniform 360 degree pattern ideal for large outdoor areas such as parking lots, corporate parks, and retail settings.

Color: White

Weight: 21.8 lbs

<b>Project:</b>	<b>Type:</b>
<b>Prepared By:</b>	<b>Date:</b>

Driver Info		LED Info	
Type:	Constant Current	Watts:	52W
120V:	0.49A	Color Temp:	5000K
208V:	0.31A	Color Accuracy:	64 CRI
240V:	0.27A	L70 Lifespan:	100000
277V:	0.24A	Lumens:	4,877
Input Watts:	59W	Efficacy:	82 LPW
Efficiency:	88%		

## Technical Specifications

### Listings

#### UL Listing:

Suitable for wet locations.

#### IESNA LM-79 & LM-80 Testing:

RAB LED luminaires have been tested by an independent laboratory in accordance with IESNA LM-79 and LM-80, and have received the Department of Energy "Lighting Facts" label.

#### DLC Listed:

This product is on the Design Lights Consortium (DLC) Qualified Products List and is eligible for rebates from DLC Member Utilities.

DLC Product Code: P00001706

### LED Characteristics

#### LEDs:

4x13W high-output, long-life LEDs.

#### Lifespan:

100,000-hour LED lifespan based on IES LM-80 results and TM-21 calculations.

#### Color Consistency:

7-step MacAdam Ellipse binning to achieve consistent fixture-to-fixture color.

#### Color Stability:

LED color temperature is warrantied to shift no more than 200K in CCT over a 5 year period.

#### Color Uniformity:

RAB's range of CCT (Correlated Color Temperature) follows the guidelines of the American National Standard for Specifications for the Chromaticity of Solid State Lighting (SSL) Products, ANSI C78.377-2011.

### Electrical

#### Drivers (2):

Constant Current, 720mA, Class 2 with 6kV surge protection, 100-277VAC, 50/60 Hz.

#### THD:

7.9% at 120V, 11.3% at 277V

### Construction

#### Cold Weather Starting:

Minimum starting temperature is -40°F / -40°C

#### Maximum Ambient Temperature:

Suitable for use in 40°C (104°F) ambient temperatures

#### Effective Projected Area:

EPA = 1.2

#### Thermal Management:

Superior thermal management with external air-flow fins

#### Housing:

Precision die-cast aluminum, Type V distribution.

#### Support Arms:

Extruded aluminum.

#### Lens:

Clear tempered glass lens.

#### Reflector:

Specular vacuum-metallized polycarbonate, Type V distribution.

#### Gaskets:

High-temperature silicone

#### Finish:

Our environmentally friendly polyester powder coatings are formulated for high-durability and long-lasting color, and contains no VOC or toxic heavy metals.

#### Green Technology:

Mercury and UV free. RoHS compliant components. Polyester powder coat finish formulated without the use of VOC or toxic heavy metals.

### Other

#### Patents:

The designs of the ALED5T52 are protected by patents pending in US, Canada, China, Taiwan and Mexico.

#### Country of Origin:

Designed by RAB in New Jersey and assembled in the USA by RAB's IBEW Local 3 workers.

#### Buy American Act Compliant:

This product is a COTS item manufactured in the United States, and is compliant with the Buy American Act.

#### Recovery Act (ARRA) Compliant:

This product complies with the 52.225-21 "Required Use of American Iron, Steel, and Manufactured Goods-- Buy American Act-- Construction Materials (October 2010).

#### Trade Agreements Act Compliant:

This product is a COTS item manufactured in the United States, and is compliant with the Trade Agreements Act.

## Technical Specifications (continued)

### Other

#### GSA Schedule:

Suitable in accordance with FAR Subpart 25.4.

### Optical

#### BUG Rating:

B3 U1 G1

## Dimensions

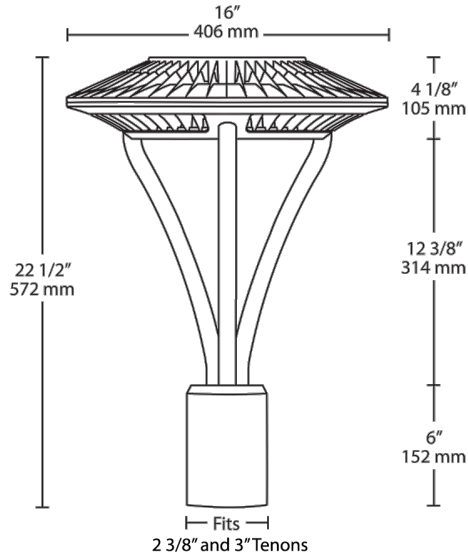

## Features

- IES type V (circular) distribution
- 100,000-hour LED lifespan
- Compatible with standard 2 3/8" and 3" tenons
- Air-flow fins for maximum heat dissipation
- 5-year warranty

## Ordering Matrix

Family	Distribution	Watts	Color Temp	Finish	Dimming	Bi-Level
ALED	5T = Type V	78 = 78W 52 = 52W 26 = 26W	Blank = 5000K (Cool) Y = 3000K (Warm) N = 4000K (Neutral)	Blank = Bronze W = White	Blank = No Dimming /D10 = Dimmable	Blank = No Bi-Level /BL = Bi-Level