

Economical linear high bay delivers versatility and ultra-high efficiency. Available in 8 wattages and three sizes, for mounting heights ranging from 15 to 60 feet. Patent pending, retractable design reduces volume by up to 60% to save valuable shelf and storage space.

Color: White

Weight: 18.7 lbs

Project:	Type:
Prepared By:	Date:

Driver Info		LED Info	
Type	Constant Current	Watts	215.00W
120V	1.79A	Color Temp	4000K (Neutral)
208V	N/A	Color Accuracy	83 CRI
240V	N/A	L70 Lifespan	100,000
277V	N/A	Lumens	29,178
Input Watts	215.80W	Efficacy	135.2 LPW
Efficiency	N/A		

Technical Specifications

Lightcloud

Lightcloud Sensor Installed:

Occupancy, vacancy, and closed loop daylight harvesting in one versatile sensor. Control any fixture in your Lightcloud system. Can also be used as a load controller. Compatible with the 8.5" reflectors. [Learn more about Lightcloud.](#)

Listings

UL Listed:

Suitable for damp locations

IESNA LM-79 & LM-80 Testing:

RAB LED luminaires and LED components have been tested by an independent laboratory in accordance with IESNA LM-79 and LM-80.

DLC Listed:

This product is listed by Design Lights Consortium (DLC) as an ultra-efficient premium product that qualifies for the highest tier of rebates from DLC Member Utilities. DLC Product Code: PG7NARGY

Construction

Operating Temperature:

-20°C (-4°F) - 50°C (122°F)

Housing:

22 gauge die formed with white powder coat finish. Y Hooks included for easy chain or cable mounting.

Reflector:

White painted, reflective, die formed painted steel

Lens:

Polycarbonate lens

Mounting:

V hooks and optional pendant mounting. AEROBAY® comes with two 42" chains.

Cord & Plug:

8 ft. cord and NEMA L7-15P twistlock plug for 277V only.

Finish:

Our environmentally friendly polyester powder coatings are formulated for high-durability and long-lasting color

Green Technology:

Mercury and UV free. RoHS-compliant components.

LED Characteristics

Lifespan:

100,000-hour LED lifespan based on IES LM-80 results and TM-21 calculations

LEDs:

Multi-chip, high-output, long-life LEDs

Color Uniformity:

RAB's range of CCT (Correlated Color Temperature) follows the guidelines of the American National Standard for Specifications for the Chromaticity of Solid State Lighting (SSL) Products, ANSI C78.377-2017.

Electrical

Driver:

Class 2, Constant Current, 120-277V, 50/60 Hz, 120V: 1.79A, 208V: 1.04A, 240V: 0.90A, 277V: 0.79A

THD:

4.9% at 120V, 7.0% at 277V

Power Factor:

99.9% at 120V, 95.5% at 277V

Battery Backup:

Emergency battery backup will operate the fixture for 90 minutes if power fails. Wired for 120-277V.

Technical Specifications (continued)

Electrical

Surge Protection:

2.5kV
For areas prone to surges, upgrade to 10kV surge protection available

Other

5 Yr Limited Warranty:

The RAB 5-year, limited warranty covers light output, driver performance and paint finish. RAB's warranty is subject to all terms and conditions found at rablighting.com/warranty.

Buy American Act Compliance:

RAB values USA manufacturing! Upon request, RAB may be able to manufacture this product to be compliant with the Buy American Act (BAA). Please contact customer service to request a quote for the product to be made BAA compliant.

Dimensions

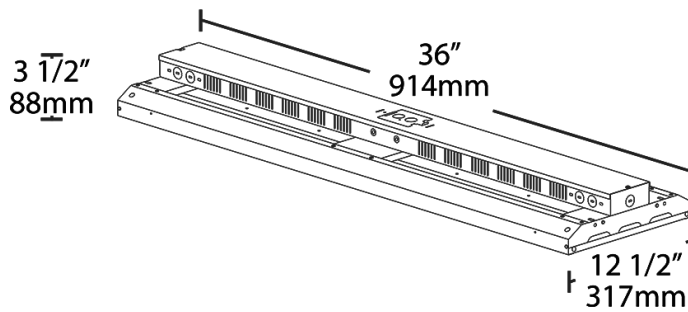

Features

- High efficiency. Low price.
- Ideal for industrial warehouse spaces
- 100,000 hour LED lifespan
- 5-Year, Limited Warranty