



Professional Grade LED Bollards compliment any pathway or landscape design. Low profile 5W Round LED comes in Cool, Warm and Neutral color temperatures. Bollards come in 18, 36 and 42" versions

Color: Bronze

Weight: 11.7 lbs

<b>Project:</b>	<b>Type:</b>
<b>Prepared By:</b>	<b>Date:</b>

Driver Info		LED Info	
Type:	Constant Current	Watts:	5W
120V:	0.2A	Color Temp:	4000K
208V:	0.12A	Color Accuracy:	85 CRI
240V:	0.1A	L70 Lifespan:	100000
277V:	N/A	Lumens:	310
Input Watts:	11W	Efficacy:	30 LPW
Efficiency:	48%		

## Technical Specifications

### Listings

#### UL Listing:

Suitable for wet locations.

#### IESNA LM-79 & IESNA LM-80 Testing:

RAB LED luminaires have been tested by an independent laboratory in accordance with IESNA LM-79 and 80, and have received the Department of Energy "Lighting Facts" label.

### LED Characteristics

#### Lifespan:

100,000-hour LED lifespan based on IES LM-80 results and TM-21 calculations.

#### Color Temperature (Nominal CCT):

4000K

#### Color Accuracy:

85 CRI

#### Color Consistency:

3-step MacAdam Ellipse binning to achieve consistent fixture-to-fixture color.

#### Color Stability:

LED color temperature is warranted to shift no more than 200K in CCT over a 5 year period.

#### Color Uniformity:

RAB's range of CCT (Correlated Color Temperature) follows the guidelines of the American National Standard for Specifications for the Chromaticity of Solid State Lighting (SSL) Products, ANSI C78.377-2011.

### Electrical

#### Driver:

Multi-chip 2x5W high output long life LED Driver  
Constant Current, Class II, 120V-240V, 50/60 Hz, 400mA.

### Construction

#### Thermal Management:

Cast aluminum Thermal Management system for optimal heat sinking. The BLEDR is designed for cool operation, most efficient output and maximum LED life by minimizing LED junction temperature.

#### Housing:

Precision die cast aluminum housing, lens frame.

#### Mounting:

36" Bollard.

#### Cold Weather Starting:

The minimum starting temperature is -40°C/-40°F

#### Maximum Ambient Temperature:

Suitable for use in 40°C (104°F) ambient temperatures

#### Gaskets:

High temperature silicone.

#### Finish:

Our environmentally friendly polyester powder coatings are formulated for high-durability and long-lasting color, and contains no VOC or toxic heavy metals.

#### Anchor Bolt:

The anchor bolts for the BLEDR's have the following dimensions 1/2 - 13 x 12 1/4" long with 2 3/4" hook.

#### Green Technology:

Mercury and UV free. RoHS compliant components. Polyester powder coat finish formulated without the use of VOC or toxic heavy metals.

### Optical

#### Lumen Maintenance:

The LED will deliver 70% of its initial lumens at 100,000 hours of operation.

#### Other

#### California Title 24:

See BLEDR2x5-36/PC for a 2013 California Title 24 compliant model.

#### Warranty:

RAB warrants that our LED products will be free from defects in materials and workmanship for a period of five (5) years from the date of delivery to the end user, including coverage of light output, color stability, driver performance and fixture finish.

#### Country of Origin:

Designed by RAB in New Jersey and assembled in the USA by RAB's IBEW Local 3 workers.

#### Buy American Act Compliant:

This product is a COTS item manufactured in the United States, and is compliant with the Buy American Act.

#### Recovery Act (ARRA) Compliant:

This product complies with the 52.225-21 "Required Use of American Iron, Steel, and Manufactured Goods-- Buy American Act-- Construction Materials (October 2010).

#### Trade Agreements Act Compliant:

This product is a COTS item manufactured in the United States, and is compliant with the Trade Agreements Act.

#### GSA Schedule:

Suitable in accordance with FAR Subpart 25.4.

## Dimensions

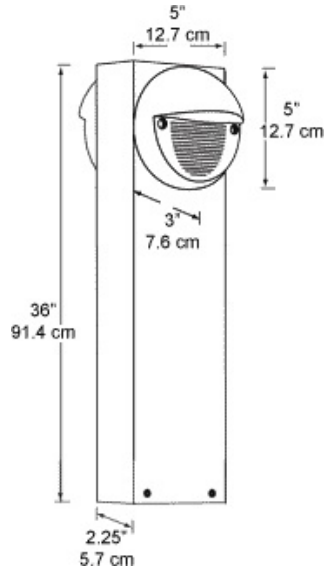

## Features

- High output LED
- 100,000 hour life
- Superior heat sinking with die cast aluminum housing
- Meets ADA Requirements