



Precision 6H x 4V optics make this 78 Watt trunnion floodlight a great choice for illuminating large signs and building facades.

Color: White

Weight: 27.5 lbs

<b>Project:</b>	<b>Type:</b>
<b>Prepared By:</b>	<b>Date:</b>

Driver Info		LED Info	
Type:	Constant Current	Watts:	78W
120V:	0.82A	Color Temp:	5000K
208V:	0.53A	Color Accuracy:	66 CRI
240V:	0.46A	L70 Lifespan:	100000
277V:	0.40A	Lumens:	8,159
Input Watts:	89W	Efficacy:	92 LPW
Efficiency:	88%		

## Technical Specifications

### Electrical

#### Photocell:

277V Swivel Photocell Included. Photocell is compatible with 208V-277V.

#### Drivers:

Constant current, Class 2, 100-277V, 50/60 Hz, 6kV Surge Protection, 720mA, 100-277V: 0.4A, THD <20%, Power Factor 99.2%

#### THD:

13.5% at 120V

### Listings

#### UL Listing:

Suitable for wet locations. Suitable for ground mounting.

#### DLC Listed:

This product is on the Design Lights Consortium (DLC) Qualified Products List and is eligible for rebates from DLC Member Utilities.

#### IESNA LM-79 & LM-80 Testing:

RAB LED luminaires have been tested by an independent laboratory in accordance with IESNA LM-79 and LM-80, and have received the Department of Energy "Lighting Facts" label.

### Construction

#### IP Rating:

Ingress Protection rating of IP66 for dust and water

#### Effective Projected Area:

EPA = 1.2

#### Cold Weather Starting:

Minimum starting temperature is -40°F/-40°C

#### Ambient Temperature:

Suitable for use in 40°C (104°F) ambient temperatures

#### Thermal Management:

Superior thermal management with external Air-Flow fins

#### Housing:

Precision die-cast aluminum housing and door frame

#### Mounting:

Trunnion mount with cord (18-3AWG ST00W 600V 105° wet location rated 3 ft.).

#### Lens:

Microprismatic diffusion lens for smooth and even light distribution

#### Reflector:

Vacuum-metalized, specular polycarbonate

#### Gaskets:

High-temperature silicone

#### Finish:

Our environmentally friendly polyester powder coatings are formulated for high-durability and long-lasting color, and contains no VOC or toxic heavy metals.

#### Green Technology:

Mercury and UV free. RoHS compliant components. Polyester powder coat finish formulated without the use of VOC or toxic heavy metals.

### LED Characteristics

#### LEDs:

Multi-chip, high-output, long-life LEDs

#### Lifespan:

100,000-hour LED lifespan based on IES LM-80 results and TM-21 calculations.

#### Color Consistency:

7-step MacAdam Ellipse binning to achieve consistent fixture-to-fixture color.

#### Color Stability:

LED color temperature is warranted to shift no more than 200K in CCT over a 5 year period.

#### Color Uniformity:

RAB's range of CCT (Correlated Color Temperature) follows the guidelines of the American National Standard for Specifications for the Chromaticity of Solid State Lighting (SSL) Products, ANSI C78.377-2011.

### Optical

#### NEMA Type:

NEMA Beam Spread of 6H x 4V

#### Replacement:

The CANVAS78 replaces 250W MH floodlights.

### Other

#### Patents:

The design of CANVAS is protected by patents in pending patents in U.S., Canada, China, Taiwan and Mexico.

## Technical Specifications (continued)

### Other

#### Country of Origin:

Designed by RAB in New Jersey and assembled in the USA by RAB's IBEW Local 3 workers.

#### Buy American Act Compliant:

This product is a COTS item manufactured in the United States, and is compliant with the Buy American Act.

#### Recovery Act (ARRA) Compliant:

This product complies with the 52.225-21 "Required Use of American Iron, Steel, and Manufactured Goods-- Buy American Act-- Construction Materials (October 2010).

#### Trade Agreements Act Compliant:

This product is a COTS item manufactured in the United States, and is compliant with the Trade Agreements Act.

#### GSA Schedule:

Suitable in accordance with FAR Subpart 25.4.

## Dimensions

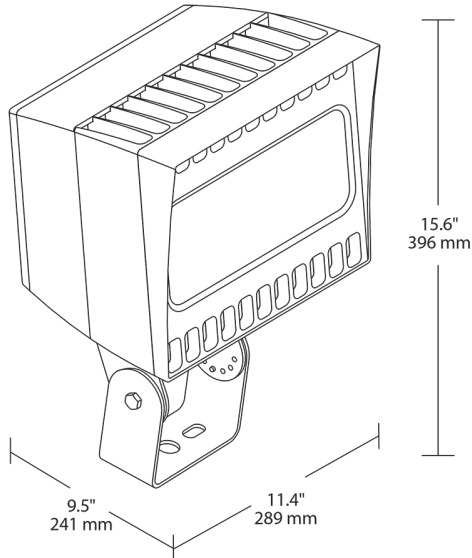

## Features

- Replaces 250W MH Floodlights
- NEMA Type 6H x 4V ideal for signage & facades
- Ultra-low field-to-beam ratio concentrates light where it's required
- Microprismatic diffusion lens optimizes light output without glare
- Superior thermal management with patent-pending "Airflow" technology
- 100,000-Hour LED lifespan

## Ordering Matrix

Family	Watts	Mount	Color Temp	Finish	Photocell	Bi-Level
CANVAS	78 = 78W	T = Trunnion	Blank = 5000K (Cool) Y = 3000K (Warm) N = 4000K (Neutral)	Blank = Bronze W = White	Blank = No Photocell /PC = 120V Button /PCS = 120V Swivel /PC2 = 277V Button /PCS2 = 277V Swivel	Blank = No Bi-Level /BL = Bi-Level