



Cylinders are a complete design solution. They are available in various sizes, mounting options, colors and beam angles, and suitable for indoor/outdoor use.

Color: Matte black

Weight: 2.4 lbs

**Project:**

**Type:**

**Prepared By:**

**Date:**

### Driver Info

Type	Constant Current
120V	0.10A
208V	0.06A
240V	0.05A
277V	0.05A
Input Watts	11.80W
Efficiency	85%

### LED Info

Watts	10W
Color Temp	3000K (Warm)
Color Accuracy	93 CRI
R9	62
L70 Lifespan	50,000
Lumens	730
Efficacy	61.9 LPW

## Technical Specifications

### Listings

#### UL Listed:

Suitable for wet locations

#### IESNA LM-79 & IESNA LM-80 Testing:

RAB LED luminaires and LED components have been tested by an independent laboratory in accordance with IESNA LM-79 and LM-80.

### Electrical

#### Driver:

Constant Current, Class 2, 120-277V, 50/60 Hz, 120V: 0.10A, 208V: 0.06A, 240V: 0.05A, 277V: 0.05A

#### Dimming Driver:

0 - 10V (at 120-277V), TRIAC and ELV (at 120V only)

#### THD:

10.2% at 120V, 25.9% at 277V

#### Power Factor:

99.2% at 120V, 87.9% at 277V

### Optical

#### Optics:

30°

### LED Characteristics

#### Lifespan:

50,000-hour LED lifespan based on IES LM-80 results and TM-21 calculations

#### LEDs:

Long-life, high-efficacy, surface-mount LEDs

#### Color Stability:

LED color temperature is warrantied to shift no more than 200K in CCT over a 5-year period

### Construction

#### Cold Weather Starting:

The minimum starting temperature is -20°C (-4°F)

#### Maximum Ambient Temperature:

Suitable for use in 40°C (104°F)

#### Lens:

TIR-Polycarbonate (Total Internal Reflection)

#### Reflector:

Vacuum-metalized polycarbonate

### Housing:

Extruded aluminum

### Mounting:

Ceiling mount

### Gaskets:

High-temperature silicone

### Green Technology:

Mercury and UV free. RoHS-compliant components.

### Finish:

Formulated for high durability and long-lasting color

### Other

#### Warranty:

RAB warrants that our LED products will be free from defects in materials and workmanship for a period of five (5) years from the date of delivery to the end user, including coverage of light output, color stability, driver performance and fixture finish. RAB's warranty is subject to all terms and conditions found at [rablighting.com/warranty](http://rablighting.com/warranty).

## Technical Specifications (continued)

### Other

#### Buy American Act Compliance:

RAB values USA manufacturing! Upon request, RAB may be able to manufacture this product to be compliant with the Buy American Act (BAA). Please contact customer service to request a quote for the product to be made BAA compliant.

### Dimensions

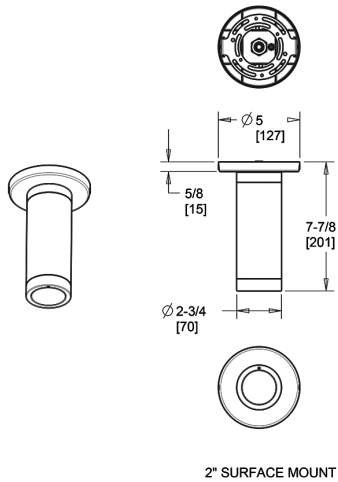

### Features

- Sleek, contemporary, architectural-grade design
- Universal dimming driver (TRIAC, ELV and 0-10V)
- 50,000-Hour LED lifespan

### Ordering Matrix

Family	Size	Mounting	Wattage	Optic	CRI/Color Temp	Finish
CDLED	2	S	10W	30D	930	K
	2 = 2"	<b>WD</b> = Wall Direct (Downlight) Only	<b>10W</b> = 10W	<b>20D</b> = 20°	<b>927</b> = 90 CRI, 2700K	<b>W</b> = Matte White
	4 = 4"	<b>WU</b> = Wall Indirect (Uplight) Only	<b>20W</b> = 20W	<b>30D</b> = 30°	<b>930</b> = 90 CRI, 3000K	<b>K</b> = Matte Black
	6 = 6"	<b>W</b> = Wall Direct/Indirect (Downlight/Uplight)	<b>26W</b> = 26W	<b>40D</b> = 40°	<b>935</b> = 90 CRI, 3500K	<b>S</b> = Matte Silver
		<b>S</b> = Surface (Ceiling Mount)	<b>40W</b> = 40W	<b>50D</b> = 50°	<b>940</b> = 90 CRI, 4000K	<b>Z</b> = Bronze
		<b>PC</b> = Pendant Cord 48" Standard		<b>80D</b> = 80°	<b>950</b> = 90 CRI, 5000K	
		<b>PS</b> = Pendant Stem		<b>WW</b> = Wall Wash		