



Cylinders are a complete design solution. They are available in various sizes, mounting options, colors and beam angles, and suitable for indoor/outdoor use.

Color: Bronze

Weight: 6.2 lbs

Project:

Type:

Prepared By:

Date:

Driver Info

Type	Constant Current
120V	0.18A
208V	0.11A
240V	0.10A
277V	0.09A
Input Watts	19.80W
Efficiency	N/A

LED Info

Watts	20W
Color Temp	5000K (Cool)
Color Accuracy	92 CRI
R9	68
L70 Lifespan	50,000
Lumens	1,800
Efficacy	90.9 LPW

Technical Specifications

Listings

UL Listed:

Suitable for wet locations

IESNA LM-79 & IESNA LM-80 Testing:

RAB LED luminaires and LED components have been tested by an independent laboratory in accordance with IESNA LM-79 and LM-80.

Electrical

Driver:

Constant Current, Class 2, 120-277V, 50/60 Hz, 120V: 0.18A, 208V: 0.11A, 240V: 0.10A, 277V: 0.09A

Dimming Driver:

0 - 10V (at 120-277V), TRIAC and ELV (at 120V only)

THD:

13.5% at 120V, 22.9% at 277V

Power Factor:

98.1% at 120V, 86% at 277V

Optical

Optics:

80°

LED Characteristics

Lifespan:

50,000-hour LED lifespan based on IES LM-80 results and TM-21 calculations

LEDs:

Long-life, high-efficacy, surface-mount LEDs

Color Stability:

LED color temperature is warranted to shift no more than 200K in CCT over a 5-year period

Construction

Cold Weather Starting:

The minimum starting temperature is -30°C (-22°F)

Maximum Ambient Temperature:

Suitable for use in 40°C (104°F)

Lens:

Solite Glass Lens and Microprismatic Diffusion Lens

Reflector:

Vacuum-metalized polycarbonate

Housing:

Extruded aluminum

Mounting:

Pendant stem (comes with components to create 12", 24", 36" or 48" in field)

Gaskets:

High-temperature silicone

Green Technology:

Mercury and UV free. RoHS-compliant components.

Finish:

Formulated for high durability and long-lasting color

Other

Warranty:

RAB warrants that our LED products will be free from defects in materials and workmanship for a period of five (5) years from the date of delivery to the end user, including coverage of light output, color stability, driver performance and fixture finish. RAB's warranty is subject to all terms and conditions found at rablighting.com/warranty.

Technical Specifications (continued)

Other

Buy American Act Compliance:

RAB values USA manufacturing! Upon request, RAB may be able to manufacture this product to be compliant with the Buy American Act (BAA). Please contact customer service to request a quote for the product to be made BAA compliant.

Dimensions

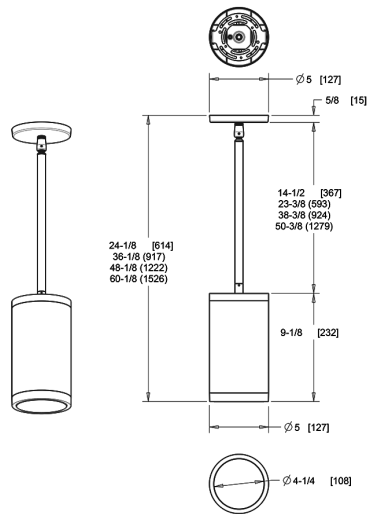

Features

- Sleek, contemporary, architectural-grade design
- Universal dimming driver (TRIAC, ELV and 0-10V)
- 50,000-Hour LED lifespan

Ordering Matrix

Family	Size	Mounting	Wattage	Optic	CRI/Color Temp	Finish
CDLED	4	PS	20W	80D	950	Z
	2 = 2"	WD = Wall Direct (Downlight) Only	10W = 10W	20D = 20°	927 = 90 CRI, 2700K	W = Matte White
	4 = 4"	WU = Wall Indirect (Uplight) Only	20W = 20W	30D = 30°	930 = 90 CRI, 3000K	K = Matte Black
	6 = 6"	W = Wall Direct/Indirect (Downlight/Uplight)	26W = 26W	40D = 40°	935 = 90 CRI, 3500K	S = Matte Silver
		S = Surface (Ceiling Mount)	40W = 40W	50D = 50°	940 = 90 CRI, 4000K	Z = Bronze
		PC = Pendant Cord 48" Standard		80D = 80°	950 = 90 CRI, 5000K	
		PS = Pendant Stem		WW = Wall Wash		