



36 Watts of energy efficient ceiling mounted LED lighting. 100,000-hour LED lifespan. 5 year warranty. Flush mount fixture bracket. LED Light Engine included.

Color: Bronze

Weight: 9.5 lbs

Project:	Type:
Prepared By:	Date:

Driver Info		LED Info	
Type:	Constant Current	Watts:	36W
120V:	0.48A	Color Temp:	4000K
208V:	0.36A	Color Accuracy:	82 CRI
240V:	0.30A	L70 Lifespan:	100000
277V:	0.24A	Lumens:	3,561
Input Watts:	40W	Efficacy:	89 LPW
Efficiency:	90%		

Technical Specifications

Listings

UL Listing:

Suitable for wet locations.

IESNA LM-79 & IESNA LM-80 Testing:

RAB LED luminaires have been tested by an independent laboratory in accordance with IESNA LM-79 and 80.

LED Characteristics

Lifespan:

100,000-hour LED lifespan based on IES LM-80 results and TM-21 calculations.

Color Consistency:

3-step MacAdam Ellipse binning to achieve consistent fixture-to-fixture color.

Color Stability:

LED color temperature is warranted to shift no more than 200K in CCT over a 5 year period.

Color Uniformity:

RAB's range of CCT (Correlated Color Temperature) follows the guidelines of the American National Standard for Specifications for the Chromaticity of Solid State Lighting (SSL) Products, ANSI C78.377-2011.

Electrical

Driver:

(2) Constant Current, Class 2, 100-277V, 50/60 Hz, 4 kV surge protection, 500mA, 100-240VAC 0.3-0.15A, 277VAC 0.15A, Power Factor 99.2

THD:

10.2% at 120V

Construction

Thermal Management:

Cast aluminum Thermal Management system for optimal heat sinking. Designed for cool operation, most efficient output and maximum LED life by minimizing LED junction temperature.

Housing:

Precision die cast aluminum and lens framing. Mounting Accessory

Cold Weather Starting:

The minimum starting temperature is -40°C/-40°F

Maximum Ambient Temperature:

Suitable for use in 40°C (104°F) ambient temperatures

Finish:

Our environmentally friendly polyester powder coatings are formulated for high-durability and long-lasting color, and contains no VOC or toxic heavy metals.

Green Technology:

Mercury and UV free. RoHS compliant components. Polyester powder coat finish formulated without the use of VOC or toxic heavy metals.

Other

Patents:

The design of the CLED is protected by U.S. Pat. D634872, Canada Pat. 133206, China Pat. ZL201030129122.3, Taiwan Pat. D139372 and Mexico Pat. 32490.

Warranty:

RAB warrants that our LED products will be free from defects in materials and workmanship for a period of five (5) years from the date of delivery to the end user, including coverage of light output, color stability, driver performance and fixture finish.

Country of Origin:

Designed by RAB in New Jersey and assembled in the USA by RAB's IBEW Local 3 workers.

Buy American Act Compliant:

This product is a COTS item manufactured in the United States, and is compliant with the Buy American Act.

Recovery Act (ARRA) Compliant:

This product complies with the 52.225-21 "Required Use of American Iron, Steel, and Manufactured Goods-- Buy American Act-- Construction Materials (October 2010).

Trade Agreements Act Compliant:

This product is a COTS item manufactured in the United States, and is compliant with the Trade Agreements Act.

GSA Schedule:

Suitable in accordance with FAR Subpart 25.4.

Optical

BUG Rating:

B1 U1 G1

Dimensions

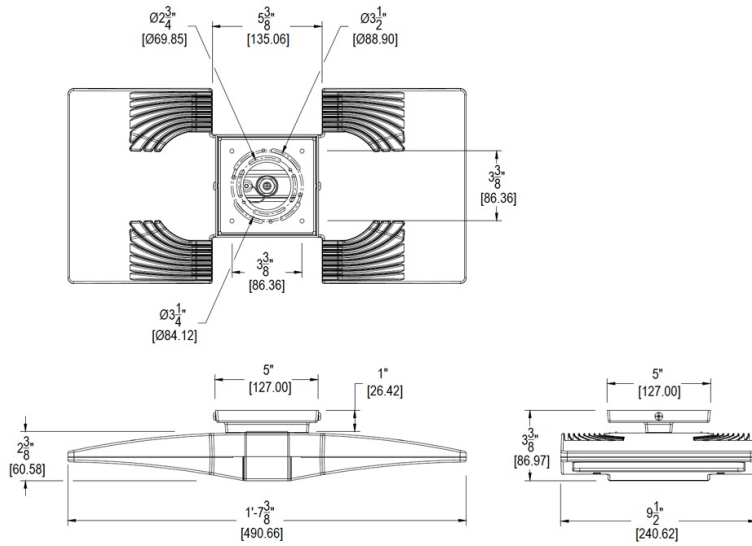

Features

- Flush mount fixture bracket
- Die cast aluminum lens frame with tempered glass and double gasketing
- Fully Shielded, Full Cutoff Optics
- LED Light Engine life delivers 70% of rated lumens at 100,000 hours
- Great for parking garages, canopies, stairwells and entrance ways
- LM-70 and LM-80 tested
- 5-year warranty

Ordering Matrix

Family	Watts	Color Temp	Finish
CLED2X	18 = 18W	Blank = 5000K (Cool) Y = 3000K (Warm) N = 4000K (Neutral)	Blank = Bronze W = White