



High performance ceiling mounted LED lighting with mini sensor. Bi-level option available. Flush mount fixture bracket.

Color: Bronze

Weight: 9.5 lbs

<b>Project:</b>	<b>Type:</b>
<b>Prepared By:</b>	<b>Date:</b>

Driver Info		LED Info	
Type:	Constant Current	Watts:	52W
120V:	0.48A	Color Temp:	4000K
208V:	N/A	Color Accuracy:	82 CRI
240V:	N/A	L70 Lifespan:	100000
277V:	N/A	Lumens:	4,688
Input Watts:	59W	Efficacy:	79 LPW
Efficiency:	88%		

## Technical Specifications

### Listings

#### UL Listing:

Suitable for damp locations.

#### IESNA LM-79 & IESNA LM-80 Testing:

RAB LED luminaires have been tested by an independent laboratory in accordance with IESNA LM-79 and LM-80, and have received the Department of Energy "Lighting Facts" label.

### LED Characteristics

#### Lifespan:

100,000-hour LED lifespan based on IES LM-80 results and TM-21 calculations.

#### LEDs:

(4) 13W Multi-chip high output, long-life LED.

#### Color Consistency:

3-step MacAdam Ellipse binning to achieve consistent fixture-to-fixture color.

#### Color Stability:

LED color temperature is warranted to shift no more than 200K in CCT over a 5 year period.

#### Color Uniformity:

RAB's range of CCT (Correlated color temperature) follows the guidelines of the American National Standard for Specifications for the Chromaticity of Solid State Lighting (SSL) Products, ANSI C78.377-2011.

#### Color Accuracy:

87 CRI

#### Color Temperature (Nominal CCT):

4000K

### Construction

#### Recommended Mounting Height:

8-10'.

#### Cold Weather Starting:

Minimum starting temperature is -40°F/-40°C.

#### Ambient Temperature:

Suitable for use in 35°C (95°F) ambient temperatures.

#### Housing:

Precision die cast aluminum housing and lens framing.

#### Gaskets:

High-temperature silicone

#### Finish:

Our environmentally friendly polyester powder coatings are formulated for high-durability and long-lasting color, and contains no VOC or toxic heavy metals.

#### Green Technology:

Mercury and UV free. RoHS compliant components. Polyester powder coat finish formulated without the use of VOC or toxic heavy metals.

### Electrical

#### Drivers (2):

Constant Current, Class 2, 100V-277V, 50/60 Hz, 6kv Surge Protection, 720mA, 100-277VAC 0.8 Amps, THD less than equal to 20%, Power Factor 99.2%.

#### Voltage:

120 volts AC 60 Hz.

### Other

#### Thermal Management (Patent Pending):

Die-cast aluminum Thermal Management system for optimal heat dissipation.

#### Patents:

RAB CLED2X26 are protected by patents in US pat. D634,879 CN ZL20103067978.

#### Warranty:

RAB warrants that our LED products will be free from defects in materials and workmanship for a period of five (5) years from the date of delivery to the end user, including coverage of light output, color stability, driver performance and fixture finish.

#### California Title 24:

CLED complies with California Title 24 building and electrical codes.

#### Country of Origin:

Designed by RAB in New Jersey and assembled in the USA by RAB's IBEW Local 3 workers.

#### Buy American Act Compliant:

This product is a COTS item manufactured in the United States, and is compliant with the Buy American Act.

#### Recovery Act (ARRA) Compliant:

This product complies with the 52.225-21 "Required Use of American Iron, Steel, and Manufactured Goods-- Buy American Act-- Construction Materials (October 2010).

#### Trade Agreements Act Compliant:

This product is a COTS item manufactured in the United States, and is compliant with the Trade Agreements Act.

## Technical Specifications (continued)

### Other

#### GSA Schedule:

Suitable in accordance with FAR Subpart 25.4.

### Optical

#### Fixture Efficacy:

44 Lumens per Watt

#### BUG Rating:

B2 U1 G1

### Sensor Characteristics

#### Sensor Switching Capacity:

5 Amps, 450 Watts LED @ 120 Volts 0.8pF Driver; 5 Amps, 300 Watts LED @ 120 Volts 0.5pF Driver.

#### Sensor Time Adjustment:

5 seconds to 15 minutes.

#### Sensor Quick Test Time:

5 second test time for fast installation. Works day or night.

#### Sensor "No Hands" Auto Testing:

Auto mode starts after 4 minutes of testing. No adjustment needed.

#### Sensor Photoelectric Control:

Deactivates lights during daylight. Fully adjustable for 24 hour operation or custom applications.

#### Sensor LED Detection Indicator:

LED glows red day & night for "on guard" deterrence.

#### Sensor RF Immunity:

Circuits fully shielded for maximum radio frequency immunity.

#### Sensor Ratings:

5 amps.

#### Sensor Power Consumption:

Negligible

#### Sensor Manual Switch:

None.

#### Sensor Ambient Light Sensing:

Adjustable.

#### Sensor Adjustments:

Time, ambient light & sensitivity.

#### Sensor Detection:

360° detection pattern.

## Dimensions

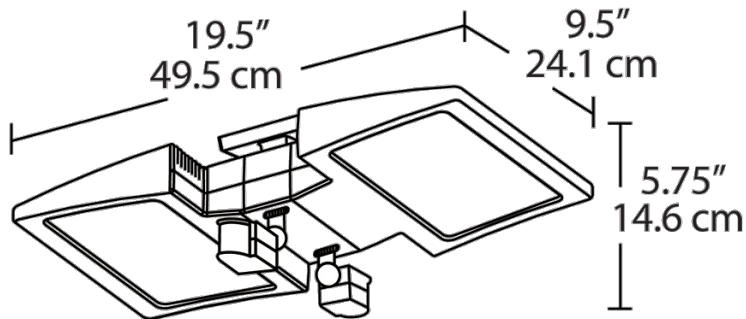

## Features

- Reduce energy usage with motion sensor technology you can rely on
- LED combined with mini sensor for an all-in-one lighting solution
- Great for small spaces like utility closets and storage rooms
- 5 year warranty