



LED ceiling light with precision optics deliver smooth and uniform distribution. Ideal for retail settings, workspace lighting and other applications requiring a high output commercial grade downlight.

Color: White

Weight: 18.0 lbs

Project:

Type:

Prepared By:

Date:

Driver Info

Type:	Constant Current
120V:	0.53A
208V:	0.35A
240V:	0.30A
277V:	0.26A
Input Watts:	58W
Efficiency:	89%

LED Info

Watts:	52W
Color Temp:	5000K
Color Accuracy:	63 CRI
L70 Lifespan:	100000
Lumens:	4,512
Efficacy:	77 LPW

Technical Specifications

Electrical

Dimming Driver:

Driver includes dimming control for 0-10V dimming systems. Requires separate 0-10V DC dimming circuit. Dims as low as 10%.

Drivers:

2x26W Driver, Constant Current, Class 2, 100V-277V, 50/60 Hz, 6kv Surge Protection, 720mA, 100-277VAC 0.4 Amps., Power Factor 99%.

THD:

8.3% at 120V, 10.6% at 277V

Listings

UL Listing:

Suitable for Wet Locations. Covered Ceiling Mount Only.

Dark Sky Approved:

The International Dark Sky Association has approved this product as a full cutoff, fully shielded luminaire.

IESNA LM-79 & LM-80 Testing:

RAB LED luminaires have been tested by an independent laboratory in accordance with IESNA LM-79 and LM-80, and have received the Department of Energy "Lighting Facts" label.

LED Characteristics

Lifespan:

100,000-hour LED lifespan based on IES LM-80 results and TM-21 calculations.

LEDs:

4x13W high-output, long-life LEDs.

Color Consistency:

7-step MacAdam Ellipse binning to achieve consistent fixture-to-fixture color.

Color Stability:

LED color temperature is warranted to shift no more than 200K in CCT over a 5 year period.

Color Uniformity:

RAB's range of CCT (Correlated Color Temperature) follows the guidelines of the American National Standard for Specifications for the Chromaticity of Solid State Lighting (SSL) Products, ANSI C78.377-2011.

Construction

Maximum Ambient Temperature:

Suitable for use in 40°C (104°F) ambient temperatures

Cold Weather Starting:

Minimum starting temperature is -40°F/-40°C.

Thermal Management:

Optimized using computational fluid dynamics software to ensure long LED and driver lifespan.

Housing:

Precision die-cast aluminum housing and lens frame.

Lens:

Clear tempered glass lens.

Gaskets:

High-temperature silicone

Finish:

Our environmentally friendly polyester powder coatings are formulated for high-durability and long-lasting color, and contains no VOC or toxic heavy metals.

Green Technology:

Mercury and UV free. RoHS compliant components. Polyester powder coat finish formulated without the use of VOC or toxic heavy metals.

Other

California Title 24:

CLED52/D10 complies with 2013 California Title 24 building and electrical codes as a commercial indoor fixture for general spaces when used with a vacancy sensor and 0-10V dimming control. Select a vacancy sensor using catalog number LVS800. 0-10V dimmer provided by others.

Patents:

The design of CLED52 is protected by patents pending in US, Canada, China, Taiwan and Mexico.

Country of Origin:

Designed by RAB in New Jersey and assembled in the USA by RAB's IBEW Local 3 workers.

Buy American Act Compliant:

This product is a COTS item manufactured in the United States, and is compliant with the Buy American Act.

Recovery Act (ARRA) Compliant:

This product complies with the 52.225-21 "Required Use of American Iron, Steel, and Manufactured Goods-- Buy American Act-- Construction Materials (October 2010).

Trade Agreements Act Compliant:

This product is a COTS item manufactured in the United States, and is compliant with the Trade Agreements Act.

GSA Schedule:

Suitable in accordance with FAR Subpart 25.4.

Technical Specifications (continued)

Optical

BUG Rating:

B2 U1 G1

Dimensions

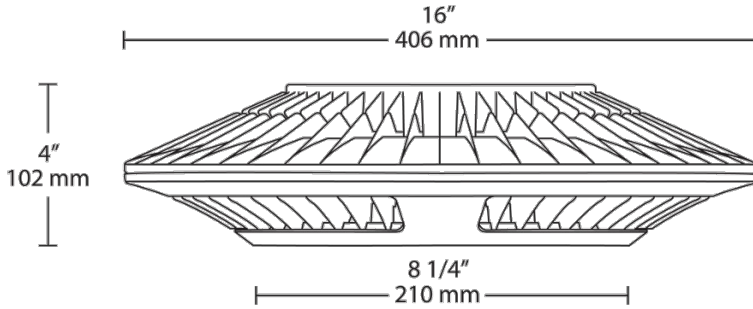

Features

- High output ceiling light
- Precision optics deliver uniform light distribution
- 100,000-hour LED lifespan
- 5-year warranty