



Now, more is less. Economical retrofit downlights with more to offer. Available in standard or adjustable heads.

Color: White

Weight: 1.0 lbs

**Project:**

**Type:**

**Prepared By:**

**Date:**

### Driver Info

Type: Constant Current  
 120V: 0.104A  
 208V: N/A  
 240V: N/A  
 277V: N/A  
 Input Watts: 12W  
 Efficiency: N/A

### LED Info

Watts: 14W  
 Color Temp: 2700K  
 Color Accuracy: 89 CRI  
 L70 Lifespan: 100000  
 Lumens: 919  
 Efficacy: 74 LPW

## Technical Specifications

### Listings

#### UL Listing:

Suitable for damp locations

#### ENERGY STAR® V2.0:

This product is ENERGY STAR® Version 2.0 Certified.

#### IESNA LM-79 & IESNA LM-80 Testing:

RAB LED luminaires have been tested by an independent laboratory in accordance with IESNA LM-79 and 80, and have received the Department of Energy "Lighting Facts" label.

### Electrical

#### Driver:

Constant Current, Class 2, 50/60 Hz, 120V: 0.104A

#### Dimming:

TRIAC, ELV and 0-10V dimming compatibility.

#### THD:

11.8% at 120V

#### Power Factor:

99.2% at 120V

### LED Characteristics

#### LEDs:

Multi-chip, high-output, long-life LEDs

#### Lifespan:

50,000-hour LED lifespan based on IES LM-80 results and TM-21 calculations.

### Construction

#### Housing:

Precision, die-cast aluminum

#### Installation:

Torsion springs for secure installation

#### Socket Adapter:

Edison 26 Medium Base Socket adapter

#### Lens:

Frosted acrylic lens

#### Finish:

Chip and fade resistant polyester powder coat finish

#### Green Technology:

Mercury and UV free. RoHS compliant components.

### Other

#### Warranty:

RAB warrants that our LED products will be free from defects in materials and workmanship for a period of five (5) years from the date of delivery to the end user, including coverage of light output, color stability, driver performance and fixture finish.

### Dimensions

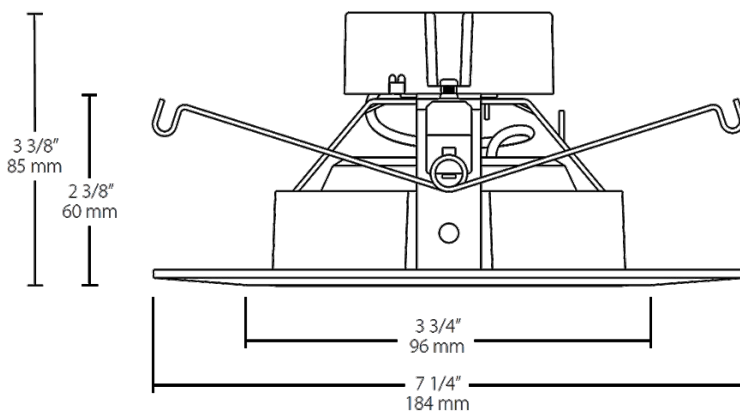

### Features

- Superior thermal management with heat-dissipating fins
- Specification-grade 90 CRI standard
- Edison E26 Medium Base socket adapter included
- 5 year no compromise warranty

## Ordering Matrix

Family	Color Temp	Size	Type	Shape	Watts
DLED	DLED	4	A	R	14
	Y = 3000K (Warm)	4 = 4"	Blank = Standard	R = Round	9 = 9W
	YY = 2700K (Residential Warm)	6 = 6"	A = Adjustable (11W in 4" & 14W in 6" only)		11 = 11W
	YN = 3500K (Warm Neutral)				14 = 14W