

product

Explosionproof junction box for wiring with cover tap it allows pendant fixture hanging.

Color: N/A

Weight: 2.9 lbs

Project:

Type:

Prepared By:

Date:

Technical Specifications

Construction

Box Construction:

Heavy wall castings. Precision machined surfaces. Four 1/4-20 screws fasten top to box.

Box Capacity:

20 cubic inches.

Finish:

Polyester powder coating.

Hub Size:

3/4" side hubs, 8 hole position.

Cover Tap:

1/2".

Electrical

Close-up Plugs:

Aluminum slotted plugs with 6 full threads. One provided for each box hole.

Other

Country of Origin:

Designed by RAB in New Jersey and assembled in the USA by RAB's IBEW Local 3 workers.

Buy American Act Compliant:

This product is a COTS item manufactured in the United States, and is compliant with the Buy American Act.

Recovery Act (ARRA) Compliant:

This product complies with the 52.225-21 "Required Use of American Iron, Steel, and Manufactured Goods-- Buy American Act-- Construction Materials (October 2010).

Trade Agreements Act Compliant:

This product is a COTS item manufactured in the United States, and is compliant with the Trade Agreements Act.

GSA Schedule:

Suitable in accordance with FAR Subpart 25.4.

Dimensions

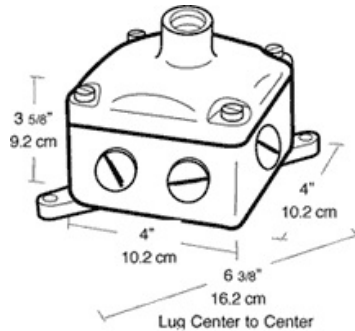

Features

- Accessory reflectors and exit signs available
- Cast aluminum junction box also serves as a hanger box for pendant fixtures
- Heavy gauge die formed aluminum
- Reflectors with white polyester powder finish