



Compact, tough and good looking cast aluminum housing with hinged framed glass lens. Integra Hood glare shield and stainless steel clip. Lamp supplied.

Color: Bronze

Weight: 6.8 lbs

Project:	Type:
Prepared By:	Date:

Lamp Info		Ballast Info	
Type:	ED17	Type:	R-NPF 120V
Watts:	70W	120V:	2.1/1.6A
Shape/Size:	N/A	208V:	N/A
Base:	N/A	240V:	N/A
ANSI:	N/A	277V:	N/A
Hours:	24,000	Input Watts:	86W
Lamp Lumens:	6,400	Efficiency:	81%
Efficacy:	74 LPW		

Technical Specifications

Listings

UL Listing:

Suitable for wet locations. Suitable for ground mounting.

Electrical

Sockets:

Porcelain with all copper current carrying components.

Socket:

Glazed porcelain 4kv pulse rated with nickel plated screw shell and spring contacts.

Construction

Housing:

Precision die cast aluminum, 1/2" NPS threaded arm with locking swivel fits all standard mounting boxes.

Reflector:

Anodized semi-specular aluminum.

Lens:

Thermal tempered shock resistant glass.

Lens Gasket:

High temperature tubular silicone set in die cast retaining groove remains in place during relamping.

Finish:

Our environmentally friendly polyester powder coatings are formulated for high-durability and long-lasting color, and contains no VOC or toxic heavy metals.

EPA:

0.43.

Other

Patents:

Pat. D420,458.

Dimensions

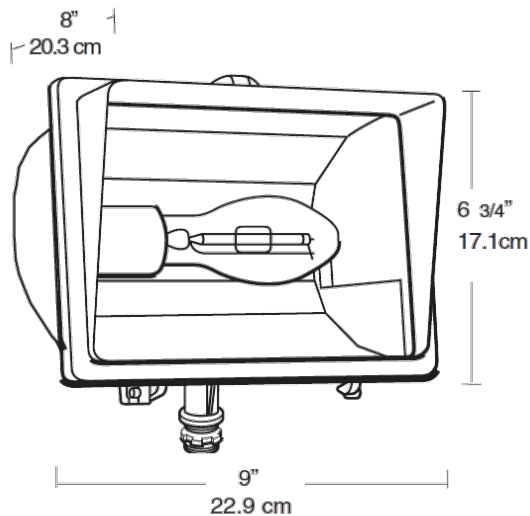

Features

- Easy clip for tool-less relamping with Vandal proof screw capability
- Integra hood glare shield for friendly lighting when properly aimed
- Silicone gasket stays in place for durable weatherproofing & easy relamping
- Precision die cast aluminum housing with durable polyester powder coating
- Variable beam spread with 2 position adjustable socket
- Long life lamp included
- Mounting arm with sturdy locking teeth & internal gasket