



Rectangular shaped LED floodlight designed to replace 70W Metal Halide. Patent Pending airflow technology ensures long LED and driver lifespan. Use for building facade lighting, sign lighting, LED landscape lighting and instant-on security lighting.

Color: Bronze

Weight: 4.8 lbs

<b>Project:</b>	<b>Type:</b>
<b>Prepared By:</b>	<b>Date:</b>

Driver Info		LED Info	
Type:	Constant Current	Watts:	18W
120V:	0.2A	Color Temp:	4000K
208V:	0.15A	Color Accuracy:	82 CRI
240V:	0.13A	L70 Lifespan:	100000
277V:	0.11A	Lumens:	2,119
Input Watts:	23W	Efficacy:	92 LPW
Efficiency:	78%		

## Technical Specifications

### Optical

#### Lumen Maintenance:

100,000-hour LED lifespan based on IES LM-80 results and TM-21 calculations.

#### NEMA Type:

NEMA Beam Spread of 7H x 6V

### Construction

#### IP Rating:

Ingress Protection rating of IP65 for dust and water.

#### Airflow:

Patent pending Airflow technology heat sink for superior cooling.

#### Ambient Temperature:

Suitable for use in 40°C ambient temperatures.

#### Cold Weather Starting:

The minimum starting temperature is -40°C/-40°F

#### Thermal Management Housing:

Die-cast aluminum housing, lens frame and mounting arm.

#### Mounting:

Heavy-duty mounting arm with "O" ring seal & stainless steel screw.

#### Reflector:

Semi-specular anodized aluminum.

#### Gaskets:

High-temperature silicone gaskets.

#### Finish:

Our environmentally friendly polyester powder coatings are formulated for high-durability and long-lasting color, and contains no VOC or toxic heavy metals.

#### Green Technology:

Mercury and UV free. RoHS compliant components. Polyester powder coat finish formulated without the use of VOC or toxic heavy metals.

### LED Characteristics

#### LEDs:

Multi-chip, high-output, long-life LEDs

#### Color Consistency:

3-step MacAdam Ellipse binning to achieve consistent fixture-to-fixture color.

#### Color Stability:

LED color temperature is warrantied to shift no more than 200K in CCT over a 5 year period.

#### Color Uniformity:

RAB's range of CCT (Correlated Color Temperature) follows the guidelines of the American National Standard for (SSL) Products, ANSI C78.377-2015.

### Electrical

#### Driver:

Constant Current, Class 2, 100 - 277V, 50 - 60 Hz, 100 - 277VAC 0.4 Amps.

#### THD:

12.1% at 120V, 10.2% at 277V

#### Power Factor:

99.1% at 120V, 96.0% at 277V

#### Surge Protection:

6kV

### Other

#### Equivalency:

The FFLED18 is Equivalent in delivered lumens to a 70W Metal Halide.

#### California Title 24:

See FFLED18/PC, FFLED18/PCS, FFLED18/PC2 or FFLED18/PCS2 for a 2013 California Title 24 compliant model.

#### Warranty:

RAB warrants that our LED products will be free from defects in materials and workmanship for a period of five (5) years from the date of delivery to the end user, including coverage of light output, color stability, driver performance and fixture finish.

#### Patents:

The FFLED design is protected by U.S. Pat. D643,147, Canada Pat. 140798, China Pat. ZL201130171304.1, Mexico Pat. 36757 and pending patent in Taiwan.

#### American Bureau of Shipping (ABS) :

For use on Mobile Offshore Drilling Units (MODU) and shipping vessels.

### Listings

#### IESNA LM-79 & LM-80 Testing:

RAB LED luminaires have been tested by an independent laboratory in accordance with IESNA LM-79 and LM-80, and have received the Department of Energy "Lighting Facts" label.

## Technical Specifications (continued)

### Listings

#### UL Listing:

Suitable For Wet Locations. Suitable for ground mounting.

### Dimensions

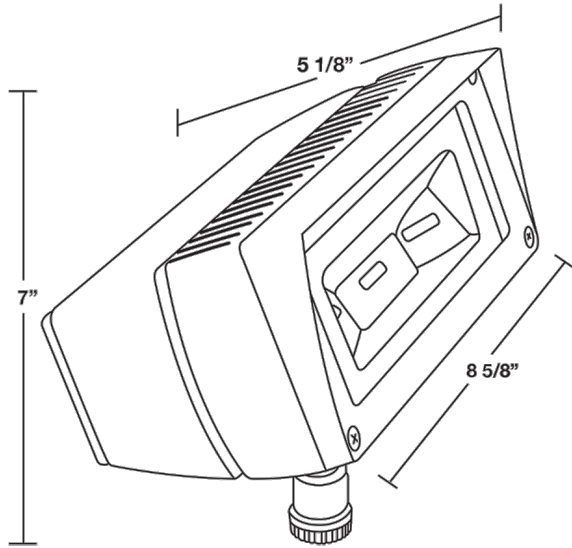

### Features

- Ultra efficient LED and optical design
- Replaces 70W MH floodlights
- 100,000 hour life based on LM-80 tests
- NEMA type - 7H x 6V
- Air-flow technology heatsink
- 5-year warranty

### Ordering Matrix

Family	Watts	Color Temp	Finish	Photocell
FFLED	18 = 18W	Blank = 5000K (Cool) Y = 3000K (Warm) N = 4000K (Neutral)	Blank = Bronze W = White	Blank = No Photocell /PC = 120V Button /PC2 = 277V Button