



Big, powerful performance, quality and value. These state of the art 1000 Watt HID floods have a full range of mounting options and accessories.

Color: Bronze

Weight: 67.7 lbs

Project:	Type:
Prepared By:	Date:

Lamp Info		Ballast Info	
Type:	BT56	Type:	CWA-HPF QT
Watts:	1000W	120V:	7.8/9.0A
Shape/Size:	N/A	208V:	4.0/5.2A
Base:	N/A	240V:	3.7/4.5A
ANSI:	N/A	277V:	3.2/3.9A
Hours:	20,000	Input Watts:	1080W
Lamp Lumens:	110,000	Efficiency:	93%
Efficacy:	102 LPW		

Technical Specifications

Listings

UL Listing:

Suitable for wet locations. Suitable for ground mounting.

Construction

Housing:

One-piece die cast aluminum with die cast door frame held captive when opened.

Reflector:

High quality anodized aluminum eliminates redirected energy to prolong lamp life. Contoured for maximum horizontal and vertical beam dispersion.

Finish:

Our environmentally friendly polyester powder coatings are formulated for high-durability and long-lasting color, and contains no VOC or toxic heavy metals.

Lens:

Thermal, tempered shock resistant glass, 5/32" thick.

Lens Gasket:

High temperature extruded silicone set in die cast retaining groove. Remains in place during relamping.

EPA:

4.2

Electrical

Socket:

3 socket positions customize beam spread to the application (center position is standard). Porcelain socket pulse rated 5K, 1500 watts and 600 volts, reinforced with cat's eyes for added durability. Silicone and fiberglass #14 gauge socket leads rated for 200°C. Plated screw shell designed to resist corrosion with spring loaded center contact.

Quad Tap:

Fixture with 120, 208, 240 and 277 Volts.

Socket:

Porcelain socket pulse rate 4kV, 1500 watts and 600 volts, reinforced with cat's eyes for added durability. Silicone and fiberglass #14 gauge socket leads rated for 200°C. Plated screw shell designed to resist corrosion with spring loaded center contact.

Other

Patents:

The unique RAB Floodinator is protected by U.S. Patents D567,980 and D572,396; China Patents ZL200730149207.6 and ZL200730149212.7; Taiwan Patent D127,687 and Canada Patents D121,990 and D121,988.

Country of Origin:

Designed by RAB in New Jersey and assembled in the USA by RAB's IBEW Local 3 workers.

Buy American Act Compliant:

This product is a COTS item manufactured in the United States, and is compliant with the Buy American Act.

Recovery Act (ARRA) Compliant:

This product complies with the 52.225-21 "Required Use of American Iron, Steel, and Manufactured Goods-- Buy American Act-- Construction Materials (October 2010).

Trade Agreements Act Compliant:

This product is a COTS item manufactured in the United States, and is compliant with the Trade Agreements Act.

GSA Schedule:

Suitable in accordance with FAR Subpart 25.4.

Dimensions

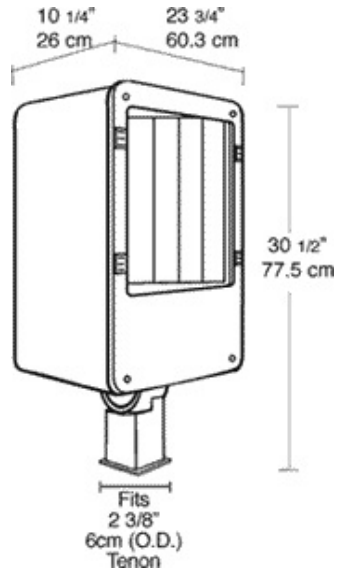

Features

- Die cast door frame held captive when opened
- Durable die cast aluminum housing and frame
- Anodized aluminum reflector
- Lamp included
- Silicone gasket for durable weatherproofing & easy relamping
- Stainless steel external hardware
- >Ballast compartment separated by anodized aluminum die formed wall