



Specification grade HID floodlight with cutting edge design, architectural quality, superior features and mounting options at competitive prices.

Color: Bronze

Weight: 16.4 lbs

<b>Project:</b>	<b>Type:</b>
<b>Prepared By:</b>	<b>Date:</b>

Lamp Info		Ballast Info	
Type:	ED17	Type:	HX-HPF QT
Watts:	70W	120V:	.8/.9A
Shape/Size:	N/A	208V:	.5/.5A
Base:	N/A	240V:	.4/.4A
ANSI:	N/A	277V:	.4/.4A
Hours:	24,000	Input Watts:	91W
Lamp Lumens:	6,300	Efficiency:	77%
Efficacy:	69 LPW		

## Technical Specifications

### Listings

#### UL Listing:

Suitable for wet locations. Suitable for ground mounting.

### Construction

#### Housing:

Precision die cast aluminum. 1/2" NPS locking Swivel Arm, Wall Bracket Trunnion or Slip Fitter.

#### Reflector:

Anodized aluminum. Field adjustable beam spread. Rotates 90° for horizontal or vertical lamp position.

#### Lens Frame & Glare Shield:

Precision die cast aluminum. Hinged for easy access. Phillips head screws for added security.

#### Finish:

Our environmentally friendly polyester powder coatings are formulated for high-durability and long-lasting color, and contains no VOC or toxic heavy metals.

#### Lens:

Thermal tempered shock resistant glass, 3/16" thick.

#### Lens Gasket:

High temperature one piece molded silicone set in die cast retaining groove. Remains in place during relamping.

#### Ground Mounting:

Use the new MPM19 PVC Mighty Post with aluminum cap for sturdy installation.

#### Ground Mounting:

Use the new MPM19 Mighty Post with aluminum cap for sturdy installation.

#### EPA:

Maximum EPA 1.1

### Electrical

#### Socket:

HID Porcelain 4kv Pulse Rated socket with nickel plated screw shell CFL Plug in type, GX24q-4 base.

#### Quad Tap:

Fixture works with 120, 208, 240 and 277 Volts.

### Other

#### Buy American Act Compliant:

This product is a COTS item manufactured in the United States, and is compliant with the Buy American Act.

#### Recovery Act (ARRA) Compliant:

This product complies with the 52.225-21 "Required Use of American Iron, Steel, and Manufactured Goods-- Buy American Act-- Construction Materials (October 2010).

#### Trade Agreements Act Compliant:

This product is a COTS item manufactured in the United States, and is compliant with the Trade Agreements Act.

#### GSA Schedule:

Suitable in accordance with FAR Subpart 25.4.

#### Patents:

Pat. D544,125.

## Dimensions

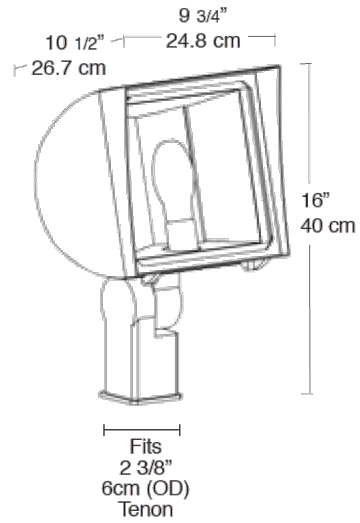

## Features

- Integra hood glare shield for friendly lighting when properly aimed
- Silicone gasket for durable weatherproofing & easy relamping
- Precision die cast aluminum housing and lens frame with durable polyester powder coating
- Anodized aluminum reflector rotates for horizontal or vertical lamp position
- Medium base 4kv pulse rated socket
- Two field adjustable socket positions allow fine tuning of beam spread)
- Fins for heat dissipation extend lamp and ballast life