



Specification Grade 400 and 250 Watt HID floodlight with cutting edge design, architectural quality, superior features and mounting options at competitive prices.

Color: Bronze

Weight: 33.8 lbs

Project:	Type:
Prepared By:	Date:

Lamp Info		Ballast Info	
Type:	ED18	Type:	CWA-HPF QT
Watts:	250W	120V:	N/A
Shape/Size:	N/A	208V:	N/A
Base:	N/A	240V:	N/A
ANSI:	N/A	277V:	0.7/1.1A
Hours:	24,000	Input Watts:	295W
Lamp Lumens:	28,500	Efficiency:	85%
Efficacy:	97 LPW		

Technical Specifications

Electrical

Photocell:

277V Swivel Photocell Included. Photocell is compatible with 208V-277V.

Socket:

HID Porcelain 4kv Pulse Rated socket with nickel plated screw shell CFL Plug in type, GX24q-4 base.

Listings

UL Listing:

Suitable for wet locations. Suitable for ground mounting.

Construction

Housing:

Precision die cast aluminum with Wall Bracket, Trunnion or Slipfitter.

Reflector:

Anodized aluminum. Field adjustable beam spread.

Lens Frame & Glare Shield:

Precision die cast aluminum. Hinged for easy access. Phillips head screws for added security.

Finish:

Our environmentally friendly polyester powder coatings are formulated for high-durability and long-lasting color, and contains no VOC or toxic heavy metals.

Lens:

Thermal tempered shock resistant glass, 3/16" thick.

Lens Gasket:

High temperature one piece molded silicone set in die cast retaining groove. Remains in place during relamping.

EPA:

Maximum EPA 2.0.

Other

Patents:

Pat. D552,283.

Country of Origin:

Designed by RAB in New Jersey and assembled in the USA by RAB's IBEW Local 3 workers.

Buy American Act Compliant:

This product is a COTS item manufactured in the United States, and is compliant with the Buy American Act.

Recovery Act (ARRA) Compliant:

This product complies with the 52.225-21 "Required Use of American Iron, Steel, and Manufactured Goods-- Buy American Act-- Construction Materials (October 2010).

Trade Agreements Act Compliant:

This product is a COTS item manufactured in the United States, and is compliant with the Trade Agreements Act.

GSA Schedule:

Suitable in accordance with FAR Subpart 25.4.

Dimensions

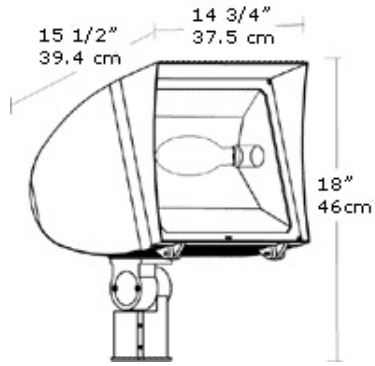

Features

- Integra hood glare shield for friendly lighting when properly aimed
- Silicone gasket for durable weatherproofing & easy relamping
- Precision die cast aluminum housing and lens frame with durable polyester powder coating
- Anodized aluminum reflector
- Mogul base 4kv pulse rated socket
- Two field adjustable socket positions allow fine tuning of beam spread
- Fins for heat dissipation extend lamp and ballast life