



Ultra high output, high efficiency LED floodlight with wide NEMA type 6H x 6V beam spread. Patent Pending airflow technology ensures long LED and driver lifespan. Use for general and security lighting for large areas, building facades, signs and landscapes.

Color: Bronze

Weight: 25.0 lbs

Project:	Type:
Prepared By:	Date:

Driver Info		LED Info	
Type:	Constant Current	Watts:	125W
120V:	N/A	Color Temp:	3000K
208V:	N/A	Color Accuracy:	80 CRI
240V:	N/A	L70 Lifespan:	100000
277V:	N/A	Lumens:	10,993
Input Watts:	135W	Efficacy:	81 LPW
Efficiency:	93%		

Technical Specifications

Listings

UL Listing:

Suitable for wet locations. Suitable for ground mounting.

IESNA LM-79 & LM-80 Testing:

RAB LED luminaires have been tested by an independent laboratory in accordance with IESNA LM-79 and LM-80, and have been received the Department of Energy "Lighting Facts" label.

LED Characteristics

Lifespan:

100,000-hour LED lifespan based on IES LM-80 results and TM-21 calculations.

LEDs:

Multi-chip, high-output, long-life LEDs

Color Consistency:

3-step MacAdam Ellipse binning to achieve consistent fixture-to-fixture color.

Color Stability:

LED color temperature is warrantied to shift no more than 200K in CCT over a 5 year period.

Color Uniformity:

RAB's range of CCT (Correlated Color Temperature) follows the guidelines of the American National Standard for Specifications for the Chromaticity of Solid State Lighting (SSL) Products, ANSI C78.377-2011.

Construction

IP Rating:

Ingress Protection rating of IP66 for dust and water.

Maximum Ambient Temperature:

Suitable for use in 40°C (104°F) ambient temperatures

Effective Projected Area:

EPA = 2

Cold Weather Starting:

The minimum starting temperature is -40°C/-40°F

Thermal Management:

Superior thermal management with external Air-Flow fins.

Housing:

Die-cast aluminum housing and door frame

Mounting:

Heavy-duty Slipfitter for 2 3/8"OD pipe.

Reflector:

Specular, vacuum-metalized polycarbonate

Gaskets:

High-temperature silicone gaskets

Finish:

Our environmentally friendly polyester powder coatings are formulated for high-durability and long-lasting color, and contains no VOC or toxic heavy metals.

Green Technology:

Mercury and UV free. RoHS compliant components. Polyester powder coat finish formulated without the use of VOC or toxic heavy metals.

Electrical

Drivers:

Two Drivers, Constant Current, Class 2, 1750mA, 347-480V, 50/60Hz, 0.30A, Power Factor 99%

Ballast Volts:

480V

Optical

NEMA Type:

NEMA Beam Spread of 6H x 6V

Replacement:

The FXLED125 replaces 320W Metal Halide Floodlights.

Sensor Characteristics

Field & Beam Angles:

Horizontal Beam Angle (50%): 91.8°, Vertical Beam Angle (50%): 73.5° Horizontal Field Angle (10%): 121.0°, Vertical Field Angle (10%): 108.0°

Other

California Title 24:

See FXLED125SF/480/PCT4 (480V) for a 2013 California Title 24 compliant product. Any additional component requirements will be listed in the Title 24 section under technical specifications on the product page.

Warranty:

RAB warrants that our LED products will be free from defects in materials and workmanship for a period of five (5) years from the date of delivery to the end user, including coverage of light output, color stability, driver performance and fixture finish.

Patents:

The design of FXLED125 is protected by patents pending in US, Canada, China, Taiwan and Mexico.

Technical Specifications (continued)

Other

Country of Origin:

Designed by RAB in New Jersey and assembled in the USA by RAB's IBEW Local 3 workers.

Buy American Act Compliant:

This product is a COTS item manufactured in the United States, and is compliant with the Buy American Act.

Recovery Act (ARRA) Compliant:

This product complies with the 52.225-21 "Required Use of American Iron, Steel, and Manufactured Goods-- Buy American Act-- Construction Materials (October 2010).

Trade Agreements Act Compliant:

This product is a COTS item manufactured in the United States, and is compliant with the Trade Agreements Act.

GSA Schedule:

Suitable in accordance with FAR Subpart 25.4.

Dimensions

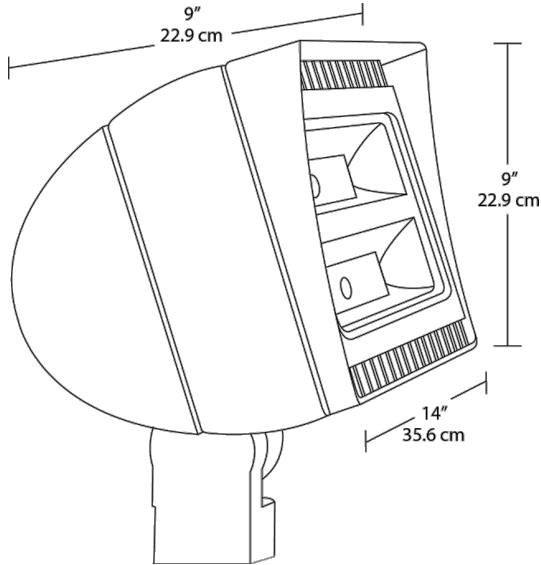

Features

- 66% energy cost savings vs. HID
- NEMA Type - 6H x 6V
- Air-Flow technology heat dissipation
- 100,000-hour LED lifespan
- 5-year warranty

Ordering Matrix

Family	Watts	Mount	Color Temp	Finish	Dimming	Voltage	Photocell	Bi-Level
FXLED	125 = 125W	T = Trunnion SF = Slipfitter	Blank = 5000K (Cool) Y = 3000K (Warm) N = 4000K (Neutral)	Blank = Bronze W = White	Blank = No Dimming /D10 = Dimmable	Blank = 120-277V /480 = 480V	Blank = No Photocell /PCT = 120-277V Twistlock Photocell /PCT4 = 480V Twistlock Photocell	Blank = No Bi-Level /BL = Bi-Level