



Ultra high output, high efficiency LED floodlight with NEMA Types: 7H x 6V, 6H x 4V, 4H x 6V, 5H x 5V and 3H x 3V. Advance thermal design ensures long LED and driver lifespan. Use for general and security lighting for large areas, building facades, signs and landscapes.

Color: Bronze

Weight: 70.5 lbs

Project:	Type:
Prepared By:	Date:

Driver Info		LED Info	
Type:	Constant Current	Watts:	500W
120V:	4.27A	Color Temp:	3000K
208V:	2.53A	Color Accuracy:	72 CRI
240V:	2.20A	L70 Lifespan:	100000
277V:	1.84A	Lumens:	56245
Input Watts:	510W	Efficacy:	110 LPW
Efficiency:	98%		

Technical Specifications

Listings

UL Listing:

Suitable for wet locations. Suitable for mounting within 1.2m (4ft) of the ground.

IESNA LM-79 & LM-80 Testing:

RAB LED luminaires have been tested by an independent laboratory in accordance with IESNA LM-79 and LM-80.

Electrical

Drivers:

Constant Current, Class 1, 120-277V, 50/60 Hz, 120V: 4.27A, 208V: 2.53A, 240V: 2.20A, 277V: 1.84A

Dimming Driver:

Driver includes dimming control wiring for 0-10V dimming systems. Requires separate 0-10V DC dimming circuit. Dims as low as 10%.

THD:

5.7% at 120V, 5.6% at 277V

Power Factor:

99.6% at 120V, 96.8% at 277V

Surge Protection:

4kV

Optical

NEMA Type:

NEMA Beam Spread of 6H x 4V

LED Characteristics

Lifespan:

100,000-hour LED lifespan based on IES LM-80 results and TM-21 calculations.

Note:

All values are typical (tolerance +/- 10%)

LEDs:

Multi-chip, high-output, long-life LEDs

Color Stability:

LED color temperature is warranted to shift no more than 200K in CCT over a 5 year period

Color Uniformity:

RAB's range of CCT (Correlated Color Temperature) follows the guidelines of the American National Standard for Specifications for the Chromaticity of Solid State Lighting (SSL) Products, ANSI C78.377-2017.

Construction

IP Rating:

Ingress Protection rating of IP66 for dust and water

Vibration Rating:

2G vibration rating per ANSI C136.31.

Cold Weather Starting:

Minimum starting temperature is -40°C (-40°F)

Ambient Temperature:

Suitable For use in 40°C (104°F) ambient temperatures.

Effective Projected Area:

EPA = 4

Thermal Management:

Superior thermal management with external "Air-Flow" fins.

Housing:

Die-cast aluminum housing with lens frame.

Mounting:

Heavy-duty Slipfitter for 2 3/8"OD pipe.

Reflector:

Specular vacuum metalized polycarbonate; semi-specular on flat trim edge.

Lens:

Clear glass lens

Gaskets:

High-temperature silicone gaskets

Finish:

Formulated for high-durability and long lasting color.

Green Technology:

Mercury and UV free. RoHS compliant components. Polyester powder coat finish formulated without the use of VOC or toxic heavy metals.

Technical Specifications (continued)

<p>Other</p> <hr/> <p>Bi-Level: Allows 25%, 50% or 75% output modes.</p> <p>American Bureau of Shipping (ABS) : For use on Mobile Offshore Drilling Units (MODU) and shipping vessels.</p>	<p>Replacement: Replaces 1500W Metal Halide</p> <p>Warranty: RAB warrants that our LED products will be free from defects in materials and workmanship for a period of five (5) years from the date of delivery to the end user, including coverage of light output, color stability, driver performance and fixture finish.</p>	<p>Buy American Act Compliance: RAB values USA manufacturing! Upon request, RAB may be able to manufacture this product to be compliant with the Buy American Act (BAA). Please contact customer service to request a quote for the product to be made BAA compliant.</p>
---	--	--

Dimensions

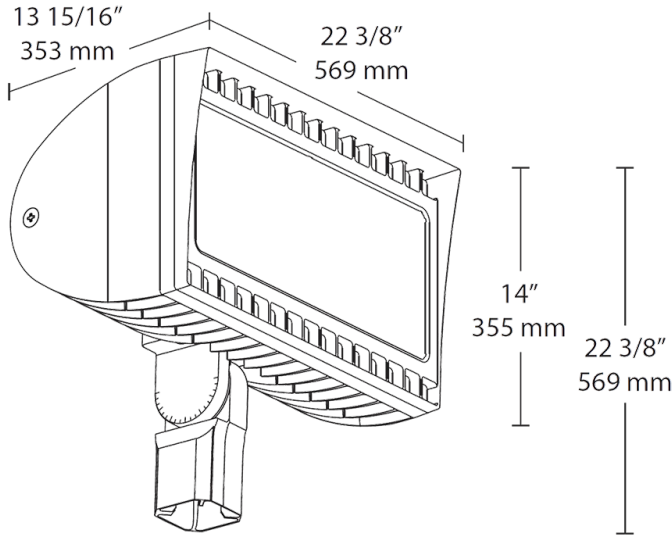

Features

- 500W replaces 1500W MH floodlights
- 100,000-hour LED lifespan
- 5-year No Compromise Warranty

Ordering Matrix

Family	Wattage	Mounting	Color Temp	Beam Option	Finish	Voltage	Driver	Options
FXLED	500	SF	Y	B64			/D10	/BL
	500 = 500W	SF = Slipfitter T = Trunnion	Blank = 5000K (Cool) N = 4000K (Neutral) Y = 3000K (Warm)	Blank = 7H x 6V B64 = 6H x 4V B55 = 5H x 5V B46 = 4H x 6V B33 = 3H x 3V	Blank = Bronze W = White	Blank = 120-277V /480 = 480V	/D10 = 0-10V Dimming (standard)	Blank = No Option /PCS = 120V Swivel Photocell /PCS2 = 277V Swivel Photocell /PCS4 = 480V Swivel Photocell /PCT = 120-277V 3PIN Twistlock Photocell /PCT4 = 480V 3PIN Twistlock Photocell /SP = 10KV Surge Suppressor /LC = Lightcloud® Controller (120-277V only) /BL = Bi-Level (120-277V only)