



Ultra high output, high efficiency LED floodlight with twistlock photocell. Available with wide NEMA type 6H x 6V beam spread. Patent Pending airflow technology ensures long LED and driver lifespan. Use for general and security lighting for large areas, building facades, signs and landscapes.

Color: White

Weight: 25.0 lbs

<b>Project:</b>	<b>Type:</b>
<b>Prepared By:</b>	<b>Date:</b>

Driver Info		LED Info	
Type:	Constant Current	Watts:	78W
120V:	N/A	Color Temp:	4000K
208V:	N/A	Color Accuracy:	81 CRI
240V:	N/A	L70 Lifespan:	100000
277V:	N/A	Lumens:	6,734
Input Watts:	81W	Efficacy:	83 LPW
Efficiency:	96%		

## Technical Specifications

### Electrical

#### Photocell:

480V Swivel Photocell Included. Photocell is only compatible with 480V.

#### Driver:

Constant Current, Class 2, 2000mA, 347-480V, 50-60Hz, 0.17A, Power Factor 99%

#### Starting/Operating Amps:

480V = 0.17A

#### Surge Protection:

4kV

#### Photocell:

480V Twistlock Photocell Included. Photocell is compatible with 480V.

### Listings

#### UL Listing:

Suitable for wet locations. Suitable for ground mounting.

#### IESNA LM-79 & LM-80 Testing:

RAB LED luminaires have been tested by an independent laboratory in accordance with IESNA LM-79 and LM-80, and have received the Department of Energy "Lighting Facts" label.

### LED Characteristics

#### Lifespan:

100,000-hour LED lifespan based on IES LM-80 results and TM-21 calculations.

#### LEDs:

Six multi-chip, 13Watt high-output, long-life LEDs.

#### Color Consistency:

3-step MacAdam Ellipse binning to achieve consistent fixture-to-fixture color.

#### Color Stability:

LED color temperature is warranted to shift no more than 200K in CCT over a 5 year period.

#### Color Uniformity:

RAB's range of CCT (Correlated Color Temperature) follows the guidelines of the American National Standard for (SSL) Products, ANSI C78.377-2015.

### Construction

#### IP Rating:

Ingress Protection rating of IP66 for dust and water.

#### EPA:

2

#### Ambient Temperature:

Suitable for use in 40°C ambient temperatures.

#### Cold Weather Starting:

The minimum starting temperature is -40°C/-40°F

#### Thermal Management:

Superior heat sinking with external Air-Flow fins.

#### Housing:

Die-cast aluminum housing and door frame.

#### Mounting:

Heavy-duty Trunnion mount with stainless steel hardware.

#### Reflector:

Specular vacuum-metallized polycarbonate

#### Gaskets:

High-temperature silicone gaskets.

#### Finish:

Our environmentally friendly polyester powder coatings are formulated for high-durability and long-lasting color, and contains no VOC or toxic heavy metals.

#### Green Technology:

Mercury and UV free. RoHS compliant components. Polyester powder coat finish formulated without the use of VOC or toxic heavy metals.

### Optical

#### NEMA Type:

NEMA Beam Spread of 6H x 6V

#### Replacement Range:

The FXLED78 can be used to replace 150 - 320W Metal Halide Floodlights based on delivered lumens.

### Other

#### Equivalency:

The FXLED78 is Equivalent in delivered lumens to a 250W Metal Halide.

## Technical Specifications (continued)

### Other

#### California Title 24:

See FXLED78SF/480/PCT4 (480V) for a 2013 California Title 24 compliant product. Any additional component requirements will be listed in the Title 24 section under technical specifications on the product page.

#### Warranty:

RAB warrants that our LED products will be free from defects in materials and workmanship for a period of five (5) years from the date of delivery to the end user, including coverage of light output, color stability, driver performance and fixture finish.

#### Patents:

The FXLED78 design is protected by U.S. Pat. D659,280, Canada Pat. 143155, China Pat. ZL201130443125.9, Mexico Pat. 36558 and pending patent in Taiwan.

#### Country of Origin:

Designed by RAB in New Jersey and assembled in the USA by RAB's IBEW Local 3 workers.

#### Buy American Act Compliant:

This product is a COTS item manufactured in the United States, and is compliant with the Buy American Act.

#### Recovery Act (ARRA) Compliant:

This product complies with the 52.225-21 "Required Use of American Iron, Steel, and Manufactured Goods-- Buy American Act-- Construction Materials (October 2010).

#### Trade Agreements Act Compliant:

This product is a COTS item manufactured in the United States, and is compliant with the Trade Agreements Act.

#### GSA Schedule:

Suitable in accordance with FAR Subpart 25.4.

## Dimensions

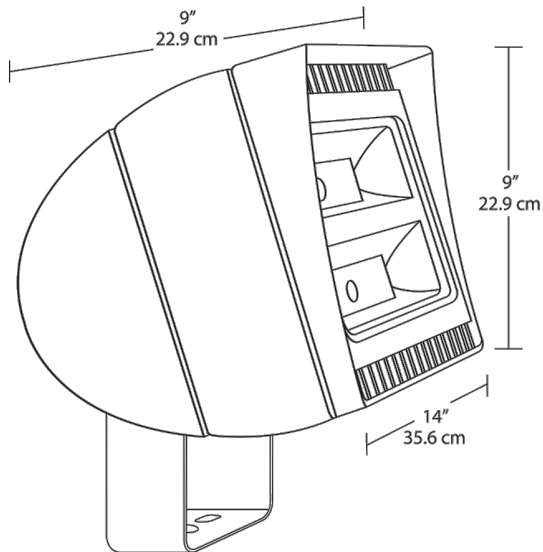

## Features

- 100,000 hour life based on LM-80 tests
- Air-flow technology heatsink
- 5-year warranty
- Twistlock Photocell