



High power, wide distribution LED floodlight. Replaces 250W MH. Patent Pending airflow technology ensures long LED and driver lifespan. Use for building facade lighting, sign lighting, LED landscape lighting and instant-on security lighting.

Color: White

Weight: 24.0 lbs

Project:	Type:
Prepared By:	Date:

Driver Info		LED Info	
Type:	Constant Current	Watts:	78W
120V:	N/A	Color Temp:	5100K
208V:	N/A	Color Accuracy:	67 CRI
240V:	N/A	L70 Lifespan:	100000
277V:	N/A	Lumens:	7,597
Input Watts:	81W	Efficacy:	94 LPW
Efficiency:	96%		

Technical Specifications

Electrical

Photocell:

480V Swivel Photocell Included. Photocell is only compatible with 480V.

Driver:

Constant Current, Class 2, 2000mA, 347-480V, 50-60Hz, 0.17A, Power Factor 99%

Starting/Operating Amps:

480V = 0.17A

Surge Protection:

4kV

Listings

UL Listing:

Suitable for wet locations. Suitable for ground mounting.

IESNA LM-79 & LM-80 Testing:

RAB LED luminaires have been tested by an independent laboratory in accordance with IESNA LM-79 and LM-80, and have received the Department of Energy "Lighting Facts" label.

LED Characteristics

Lifespan:

100,000-hour LED lifespan based on IES LM-80 results and TM-21 calculations.

LEDs:

Six multi-chip, 13Watt high-output, long-life LEDs.

Color Consistency:

7-step MacAdam Ellipse binning to achieve consistent fixture-to-fixture color.

Color Stability:

LED color temperature is warranted to shift no more than 200K in CCT over a 5 year period.

Color Uniformity:

RAB's range of CCT (Correlated Color Temperature) follows the guidelines of the American National Standard for (SSL) Products, ANSI C78.377-2015.

Construction

IP Rating:

Ingress Protection rating of IP66 for dust and water.

EPA:

2

Ambient Temperature:

Suitable for use in 40°C ambient temperatures.

Cold Weather Starting:

The minimum starting temperature is -40°C/-40°F

Thermal Management:

Superior heat sinking with external Air-Flow fins.

Housing:

Die-cast aluminum housing and door frame.

Mounting:

Heavy-duty Trunnion mount with stainless steel hardware.

Reflector:

Specular vacuum-metallized polycarbonate

Gaskets:

High-temperature silicone gaskets.

Finish:

Our environmentally friendly polyester powder coatings are formulated for high-durability and long-lasting color, and contains no VOC or toxic heavy metals.

Green Technology:

Mercury and UV free. RoHS compliant components. Polyester powder coat finish formulated without the use of VOC or toxic heavy metals.

Optical

NEMA Type:

NEMA Beam Spread of 6H x 6V

Replacement Range:

The FXLED78 can be used to replace 150 - 320W Metal Halide Floodlights based on delivered lumens.

Other

Equivalency:

The FXLED78 is Equivalent in delivered lumens to a 250W Metal Halide.

California Title 24:

See FXLED78SF/480/PCT4 (480V) for a 2013 California Title 24 compliant product. Any additional component requirements will be listed in the Title 24 section under technical specifications on the product page.

Technical Specifications (continued)

Other

Warranty:

RAB warrants that our LED products will be free from defects in materials and workmanship for a period of five (5) years from the date of delivery to the end user, including coverage of light output, color stability, driver performance and fixture finish.

Patents:

The FXLED78 design is protected by U.S. Pat. D659,280, Canada Pat. 143155, China Pat. ZL201130443125.9, Mexico Pat. 36558 and pending patent in Taiwan.

Country of Origin:

Designed by RAB in New Jersey and assembled in the USA by RAB's IBEW Local 3 workers.

Buy American Act Compliant:

This product is a COTS item manufactured in the United States, and is compliant with the Buy American Act.

Recovery Act (ARRA) Compliant:

This product complies with the 52.225-21 "Required Use of American Iron, Steel, and Manufactured Goods-- Buy American Act-- Construction Materials (October 2010).

Trade Agreements Act Compliant:

This product is a COTS item manufactured in the United States, and is compliant with the Trade Agreements Act.

GSA Schedule:

Suitable in accordance with FAR Subpart 25.4.

Dimensions

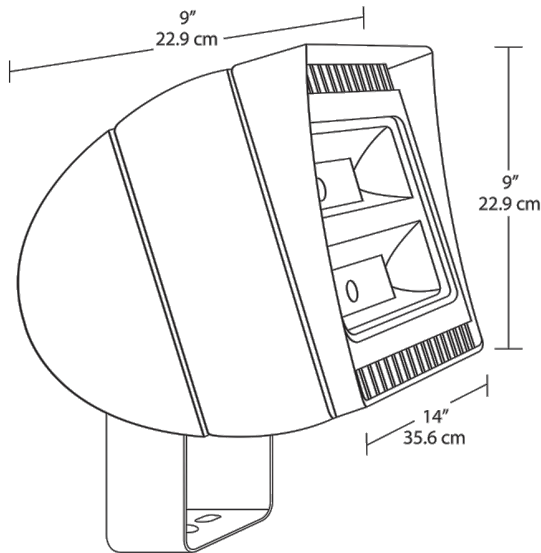

Features

- 78 Watt high-performance LED
- Replaces 250W MH floodlights
- 100,000 hour life based on LM-80 tests
- Air-flow technology heatsink
- NEMA type - 6H x 6V
- Slipfitter and trunnion mounting available
- 5-year warranty

Ordering Matrix

Family	Watts	Mount	Color Temp	Finish	Dimming	Voltage	Photocell	Bi-Level
FXLED	78 = 78W	Blank = Arm T = Trunnion SF = Slipfitter	Blank = 5000K (Cool) Y = 3000K (Warm) N = 4000K (Neutral)	Blank = Bronze W = White	Blank = No Dimming /D10 = Dimmable	Blank = 120-277V /480 = 480 Volt	Blank = No Photocell /PCT = 120-277V Twistlock Photocell /PCT4 = 480V Twistlock Photocell	Blank = No Bi-Level /BL = Bi-Level