



Project:	Type:
Prepared By:	Date:

Technical Specifications

Other

Threads:

1/2" NPS at the fixture Side.

Country of Origin:

Designed by RAB in New Jersey and assembled in Taiwan.

Trade Agreements Act Compliant:

This product is a product of Taiwan and a "designated country" end product that complies with the Trade Agreements Act.

GSA Schedule:

Suitable in accordance with FAR Subpart 25.4.

Construction

Diameter:

Diameter of the tube is 1".

Mounting:

The wall plate does not mount to a junction box but directly to the mounting surface with the proper hardware for the surface.

Component Only:

This is a component for ordering LED Goosenecks. Not a complete fixture without Shade and Head.

Construction:

Die cast aluminum

Finish:

Our environmentally friendly polyester powder coatings are formulated for high-durability and long-lasting color, and contains no VOC or toxic heavy metals. Offers significantly improved gloss retention and resistance to color change.

Dimensions

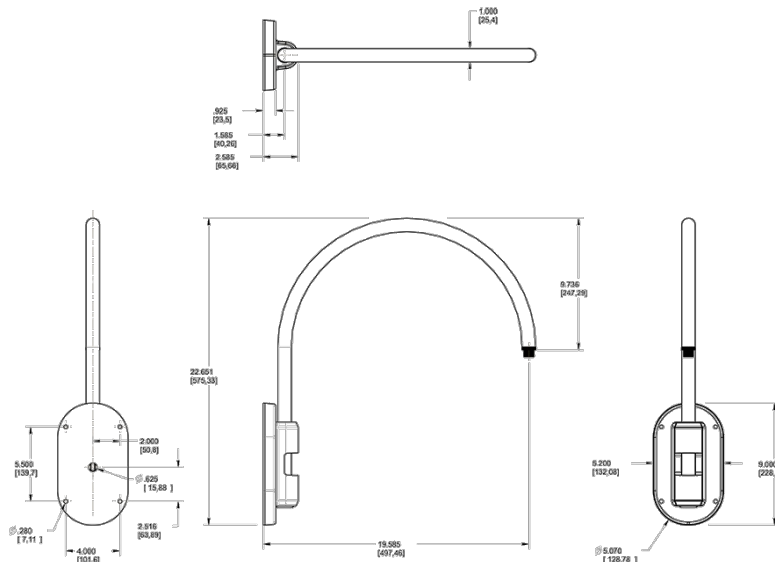

Ordering Matrix

Family	Style	Finish
GOOSE	4	B

- 1 = Arm Style 1
- 2 = Arm Style 2
- 3 = Arm Style 3
- 4 = Arm Style 4
- 5 = Arm Style 5

- B** = Black
- W** = White
- A** = Bronze
- S** = Silver
- G** = Hunter Green
- YL** = Yellow
- LB** = Light Blue
- BL** = Royal Blue
- BWN** = Brown
- I** = Ivory
- R** = Red