



78 Watts of energy efficient LED garage lighting replaces 250 Watt Metal Halide. 100,000 hour LED lifespan. 5 year warranty. High-performance output maximizes spacing criterion.

Color: White

Weight: 18.2 lbs

<b>Project:</b>	<b>Type:</b>
<b>Prepared By:</b>	<b>Date:</b>

Driver Info		LED Info	
Type:	Constant Current	Watts:	78W
120V:	N/A	Color Temp:	5100K
208V:	N/A	Color Accuracy:	68 CRI
240V:	N/A	L70 Lifespan:	100000
277V:	N/A	Lumens:	7,053
Input Watts:	88W	Efficacy:	80 LPW
Efficiency:	88%		

## Technical Specifications

### Listings

#### UL Listing:

Suitable for wet locations.

#### IESNA LM-79 & LM-80 Testing:

RAB LED luminaires have been tested by an independent laboratory in accordance with IESNA LM-79 and LM-80, and have received the Department of Energy "Lighting Facts" label.

### Optical

#### Lumen Maintenance:

100,000-hour LED lifespan based on IES LM-80 results and TM-21 calculations.

#### BUG Rating:

B3 U3 G2

### LED Characteristics

#### LEDs:

6x13W high-output, long-life LEDs.

#### Color Consistency:

7-step MacAdam Ellipse binning to achieve consistent fixture-to-fixture color.

#### Color Stability:

LED color temperature is warrantied to shift no more than 200K in CCT over a 5 year period.

#### Color Uniformity:

RAB's range of CCT (Correlated Color Temperature) follows the guidelines of the American National Standard for Specifications for the Chromaticity of Solid State Lighting (SSL) Products, ANSI C78.377-2011.

### Electrical

#### Drivers:

3x26W Driver, Constant Current, Class 2, 100V-277V, 50/60 Hz, 6kv Surge Protection, 720mA, 100-277VAC 0.4 Amps.

#### Dimming Driver:

Driver includes dimming control for 0-10V dimming systems. Requires separate 0-10V DC dimming circuit. Dims as low as 10%.

### Construction

#### Cold Weather Starting:

Minimum starting temperature is -40°C (-40°F).

#### Maximum Ambient Temperature:

Suitable for use in 40°C (104°F) ambient temperatures

#### Thermal Management:

Superior heat sinking with integrated air-flow fins.

#### Housing:

Precision die-cast aluminum housing and door frame.

#### Mounting:

Pendant provided by others. Threads are 1/2 inch NPS. Stem insertion depth not to exceed 5/8 inch. Lock screw provided on fixture.

#### Lens:

Prismatic polycarbonate lens.

#### Reflector:

Specular vacuum-metallized polycarbonate

#### Gaskets:

High-temperature silicone

#### Finish:

Our environmentally friendly polyester powder coatings are formulated for high-durability and long-lasting color, and contains no VOC or toxic heavy metals.

#### Green Technology:

Mercury and UV free. RoHS compliant components. Polyester powder coat finish formulated without the use of VOC or toxic heavy metals.

### Other

#### Equivalency:

The GPLED78 is Equivalent in delivered lumens to 250W Metal Halide.

#### Country of Origin:

Designed by RAB in New Jersey and assembled in the USA by RAB's IBEW Local 3 workers.

#### Buy American Act Compliant:

This product is a COTS item manufactured in the United States, and is compliant with the Buy American Act.

#### Trade Agreements Act Compliant:

This product is a COTS item manufactured in the United States, and is compliant with the Trade Agreements Act.

#### GSA Schedule:

Suitable in accordance with FAR Subpart 25.4.

#### California Title 24:

See GPLED78BB/BL or GPLED52/D10 for a 2013 California Title 24 compliant product. Any additional component requirements will be listed in the Title 24 section under technical specifications on the product page.

## Technical Specifications (continued)

### Other

### Patents:

The design of GPLED78 is protected by patents pending in US, Canada, China, Taiwan and Mexico.

### Dimensions

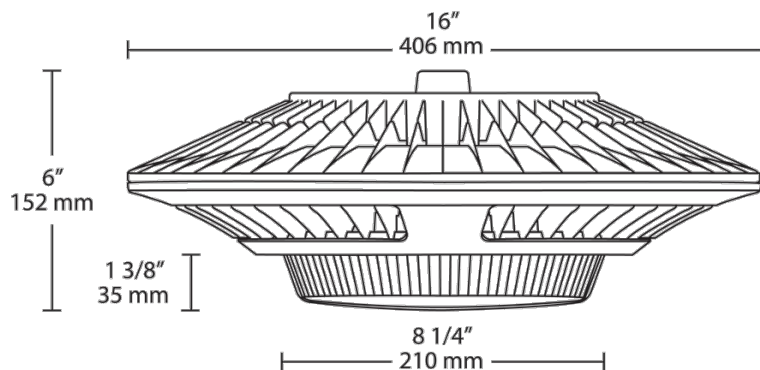

### Features

- Low-profile design Ideal for Parking Garages
- 78W Replaces 250W MH Luminaires
- 100,000-hour LED lifespan based on IES LM-80 results and TM-21 calculations
- Up to 25% Reduction in Fixture Count
- Lock screw provided for pendant mount