



78 Watts of energy efficient LED garage lighting replaces 250 Watt Metal Halide. 100,000 hour LED lifespan. 5 year warranty. High-performance output maximizes spacing criterion.

Color: Bronze

Weight: 18.2 lbs

Project:	Type:
Prepared By:	Date:

Driver Info		LED Info	
Type:	Constant Current	Watts:	78W
120V:	N/A	Color Temp:	3000K
208V:	N/A	Color Accuracy:	83 CRI
240V:	N/A	L70 Lifespan:	100000
277V:	N/A	Lumens:	5,762
Input Watts:	90W	Efficacy:	64 LPW
Efficiency:	87%		

Technical Specifications

Listings

UL Listing:

Suitable for wet locations.

IESNA LM-79 & LM-80 Testing:

RAB LED luminaires have been tested by an independent laboratory in accordance with IESNA LM-79 and LM-80, and have received the Department of Energy "Lighting Facts" label.

Optical

Lumen Maintenance:

100,000-hour LED lifespan based on IES LM-80 results and TM-21 calculations.

BUG Rating:

B3 U3 G2

LED Characteristics

LEDs:

6x13W high-output, long-life LEDs.

Color Consistency:

3-step MacAdam Ellipse binning to achieve consistent fixture-to-fixture color.

Color Stability:

LED color temperature is warrantied to shift no more than 200K in CCT over a 5 year period.

Color Uniformity:

RAB's range of CCT (Correlated Color Temperature) follows the guidelines of the American National Standard for Specifications for the Chromaticity of Solid State Lighting (SSL) Products, ANSI C78.377-2011.

Electrical

Drivers:

3x26W Driver, Constant Current, Class 2, 100V-277V, 50/60 Hz, 6kv Surge Protection, 720mA, 100-277VAC 0.4 Amps.

Dimming Driver:

Driver includes dimming control for 0-10V dimming systems. Requires separate 0-10V DC dimming circuit. Dims as low as 10%.

Construction

Cold Weather Starting:

Minimum starting temperature is -40°C (-40°F).

Maximum Ambient Temperature:

Suitable for use in 40°C (104°F) ambient temperatures

Thermal Management:

Superior heat sinking with integrated air-flow fins.

Housing:

Precision die-cast aluminum housing and door frame.

Mounting:

Pendant provided by others. Threads are 1/2 inch NPS. Stem insertion depth not to exceed 5/8 inch. Lock screw provided on fixture.

Lens:

Prismatic polycarbonate lens.

Reflector:

Specular vacuum-metallized polycarbonate

Gaskets:

High-temperature silicone

Finish:

Our environmentally friendly polyester powder coatings are formulated for high-durability and long-lasting color, and contains no VOC or toxic heavy metals.

Green Technology:

Mercury and UV free. RoHS compliant components. Polyester powder coat finish formulated without the use of VOC or toxic heavy metals.

Other

Equivalency:

The GPLED78 is Equivalent in delivered lumens to 250W Metal Halide.

Country of Origin:

Designed by RAB in New Jersey and assembled in the USA by RAB's IBEW Local 3 workers.

Buy American Act Compliant:

This product is a COTS item manufactured in the United States, and is compliant with the Buy American Act.

Trade Agreements Act Compliant:

This product is a COTS item manufactured in the United States, and is compliant with the Trade Agreements Act.

GSA Schedule:

Suitable in accordance with FAR Subpart 25.4.

California Title 24:

See GPLED78BB/BL or GPLED52/D10 for a 2013 California Title 24 compliant product. Any additional component requirements will be listed in the Title 24 section under technical specifications on the product page.

Technical Specifications (continued)

Other

Patents:

The design of GPLED78 is protected by patents pending in US, Canada, China, Taiwan and Mexico.

Dimensions

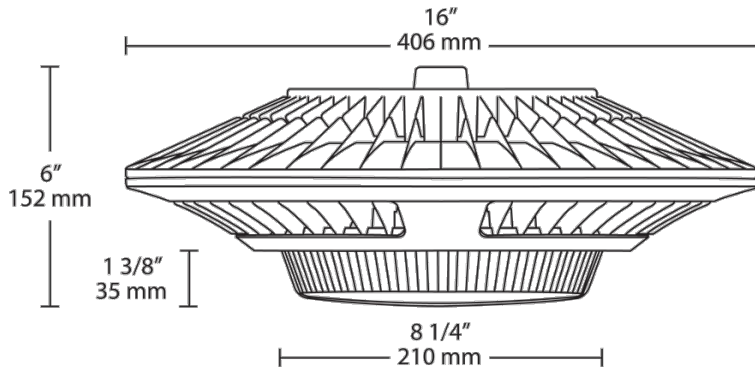

Features

Low-profile design Ideal for Parking Garages

78W Replaces 250W MH Luminaires

100,000-hour LED lifespan based on IES LM-80 results and TM-21 calculations

Up to 25% Reduction in Fixture Count

Lock screw provided for pendant mount