



Color: N/A

Weight: 0.8 lbs

<b>Project:</b>	<b>Type:</b>
<b>Prepared By:</b>	<b>Date:</b>

Driver Info		LED Info	
Type:	Constant Current	Watts:	8W
120V:	0.11A	Color Temp:	N/A
208V:	0.05A	Color Accuracy:	N/A
240V:	0.04A	L70 Lifespan:	50000
277V:	0.03A	Lumens:	3668
Input Watts:	0W	Efficacy:	N/A
Efficiency:	N/A		

## Technical Specifications

### Listings

#### UL Listed:

Suitable for wet locations in a covered ceiling

### Optical

#### Photometrics:

Photometrics are based on prorated reports. Contact the RAB Lighting Design department for the most up-to-date data.

#### Optic:

The HALED Light Engine comes standard with an 80° optic with frosted lens installed

### Electrical

#### Driver:

Class 2, 120-277V, 50/60 Hz, 120V: 0.11A, 208V: 0.05A, 240V: 0.041A, 277V: 0.04A

#### Dimming Driver:

Compatible with TRIAC dimming at 120V.

#### Surge Protection:

4kV

### LED Characteristics

#### Lifespan:

50,000-hour LED lifespan based on IES LM-80 results and TM-21 calculations

#### LEDs:

Long-life, high-efficiency, surface mount LEDs

### Construction

#### IC Rating:

Suitable for direct contact with insulation

#### Housing:

Precision die cast aluminum

#### Trim:

Spun aluminum, Alzak anodized, and luxurious electroplated finishes available

#### Lens:

Standard, frosted lens eliminates "hot spots", and helps provide smooth, uniform light

### Green Technology:

Mercury and UV-free. RoHS compliant components. Polyester powder coat finish formulated without the use of VOCs or toxic heavy metals.

#### Finish:

Formulated for high-durability and long lasting color

### Other

#### Warranty:

RAB warrants that our LED products will be free from defects in materials and workmanship for a period of five (5) years from the date of delivery to the end user, including coverage of light output, color stability, driver performance and fixture finish.

### Buy American Act Compliance:

RAB values USA manufacturing! Upon request, RAB may be able to manufacture this product to be compliant with the Buy American Act (BAA). Please contact customer service to request a quote for the product to be made BAA compliant.

## Dimensions

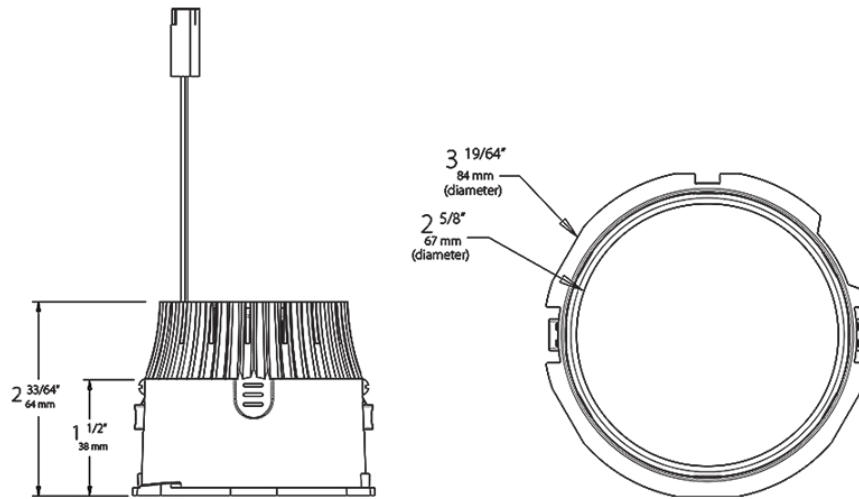

## Ordering Matrix

Family	Wattage	Beam Spread	Color Temp	CRI
HALED	8	80	N	HC
	8 = 8W 12 = 12W	80FR = 80° Frosted Lens	N = 4000K (Neutral) YN = 3500K (Warm Neutral) Y = 3000K (Warm) YY = 2700K (Residential Warm)	Blank = 80 CRI HC = 90 CRI