



Bullet shape die cast aluminum flood with 13 Watt LED Light Engine. Comes with narrow spotlight reflector installed.

Color: Verde green

Weight: 4.6 lbs

Project:	Type:
Prepared By:	Date:

Driver Info		LED Info	
Type:	Constant Current	Watts:	13W
120V:	0.12A	Color Temp:	4000K
208V:	0.09A	Color Accuracy:	81 CRI
240V:	0.08A	L70 Lifespan:	100000
277V:	0.07A	Lumens:	1,055
Input Watts:	15W	Efficacy:	73 LPW
Efficiency:	90%		

Technical Specifications

Listings

UL Listing:

Suitable for wet locations. Suitable for ground mounting.

IESNA LM-79 & LM-80 Testing:

RAB LED luminaires have been tested by an independent laboratory in accordance with IESNA LM-79 and LM-80, and have received the Department of Energy "Lighting Facts" label.

Electrical

Driver:

Multi-chip 13W high output long life LED Driver Constant Current, 100V - 277V, 50/60 Hz.

THD:

9.5% at 120V

Power Factor:

99.0% at 120V

Dimming Driver:

Driver includes dimming control for 0-10V dimming systems. Requires separate 0-10V DC dimming circuit. Dims as low as 10%.

Optical

NEMA Type:

2H x 2V Beam Spread.

LED Characteristics

LEDs:

Multi-chip, high-output, long-life LEDs

Color Stability:

RAB LEDs exceed industry standards for chromatic stability.

Color Uniformity:

RAB's range of CCT (Correlated Color Temperature) follows the guidelines of the American National Standard for Specifications for the Chromaticity of Solid State Lighting (SSL) Products, ANSI C78.377-2011.

Construction

Cold Weather Starting:

Minimum starting temperature is -40°F/-40°C

Thermal Management:

Superior heat sinking with external Air-Flow fins

Housing:

Precision die-cast aluminum housing, lens frame and mounting arm.

Reflector:

Semi-specular, vacuum-metalized polycarbonate

Mounting:

Heavy-duty mounting arm with "O" ring seal & stainless steel screws.

Gaskets:

High-temperature silicone gaskets

Finish:

Our environmentally friendly polyester powder coatings are formulated for high-durability and long-lasting color, and contain no VOC or toxic heavy metals.

Green Technology:

Mercury and UV free. RoHS compliant components. Polyester powder coat finish formulated without the use of VOC or toxic heavy metals.

Other

Country of Origin:

Designed by RAB in New Jersey and assembled in the USA by RAB's IBEW Local 3 workers.

Buy American Act Compliant:

This product is a COTS item manufactured in the United States, and is compliant with the Buy American Act.

Recovery Act (ARRA) Compliant:

This product complies with the 52.225-21 "Required Use of American Iron, Steel, and Manufactured Goods-- Buy American Act-- Construction Materials (October 2010).

Trade Agreements Act Compliant:

This product is a COTS item manufactured in the United States, and is compliant with the Trade Agreements Act.

GSA Schedule:

Suitable in accordance with FAR Subpart 25.4.

Dimensions

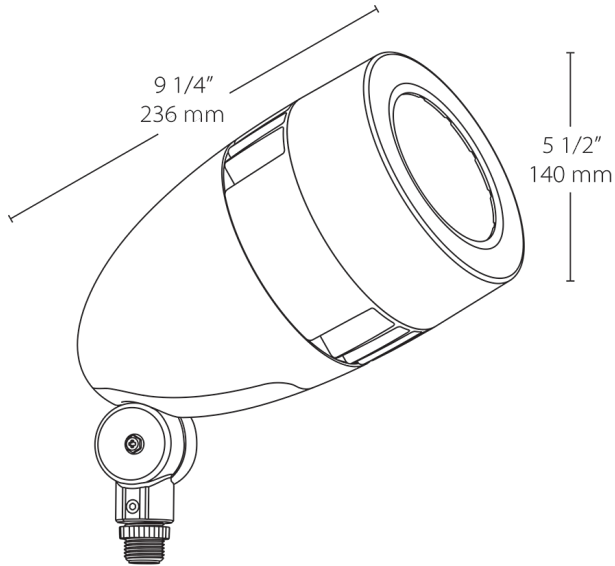

Features

- 80% energy savings vs. PAR floods
- Mount on junction box or on RAB Mighty Post
- Patent-pending Air-Flow technology
- 5-year warranty