

HS90-A



Project:	Type:
Prepared By:	Date:

Hang straight swivels make mounting pendants to sloped ceilings easy.

Color: Bronze

Weight: 0.2 lbs

Technical Specifications

Other

Description:

Hang straight 90° 1/2" NPS swivel mount sloped ceiling.

Maximum Weight:

HS90 suspends a light fixture with a maximum weight of 70 lbs.

Construction

Material:

Precision die cast aluminum.

Finish:

Our environmentally friendly polyester powder coatings are formulated for high-durability and long-lasting color, and contains no VOC or toxic heavy metals.

Dimensions

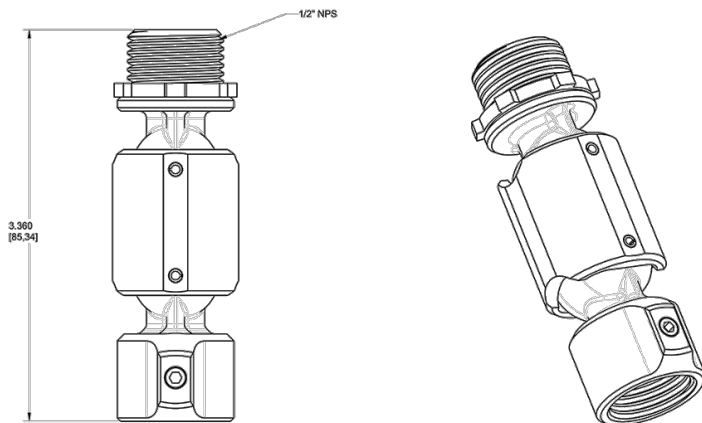

Features

Available in bronze and white and 45 or 90 degree angles

Fits 1/2" NPS