



Bullet shape die cast aluminum flood with spotlighting for over 40 feet away. 13 Watt LED High Performance Light Engine.

Color: Black

Weight: 4.6 lbs

<b>Project:</b>	<b>Type:</b>
<b>Prepared By:</b>	<b>Date:</b>

Driver Info		LED Info	
Type:	Constant Current	Watts:	13W
120V:	0.12A	Color Temp:	3000K
208V:	0.09A	Color Accuracy:	87 CRI
240V:	0.08A	L70 Lifespan:	100000
277V:	0.07A	Lumens:	1,089
Input Watts:	14W	Efficacy:	76 LPW
Efficiency:	91%		

## Technical Specifications

### Listings

#### UL Listing:

Suitable for wet locations. Suitable for ground mounting.

#### IESNA LM-79 & IESNA LM-80 Testing:

RAB LED luminaires have been tested by an independent laboratory in accordance with IESNA LM-79 and 80, and have received the Department of Energy "Lighting Facts" label.

### LED Characteristics

#### Lifespan:

100,000-hour LED lifespan based on IES LM-80 results and TM-21 calculations.

#### LEDs:

13 Watt high output, long-life LED.

#### Color Consistency:

3-step MacAdam Ellipse binning to achieve consistent fixture-to-fixture color.

#### Color Stability:

LED color temperature is warranted to shift no more than 200K in CCT over a 5 year period.

#### Color Accuracy:

87 CRI

#### Color Temperature (Nominal CCT):

3000K

#### Color Uniformity:

RAB's range of CCT (Correlated Color Temperature) follows the guidelines of the American National Standard for (SSL) Products, ANSI C78.377-2015.

### Optical

#### Spotlight Distribution:

Beam Angle of 11° and Field Angle of 24° enables the HSLED to produce a very narrow spot distribution.

#### Lumen Maintenance:

100,000 hours Life Based on LM-80 Tests.

#### Fixture Efficacy:

36 Lumens per Watt

#### NEMA Type:

2H x 2V Beam Spread.

### Electrical

#### Driver:

Constant Current, Class 2, 100-277V, 50-60Hz, 100-240VAC 0.3-0.15A, 277VAC 0.15A.

#### THD:

21.1% at 120V

#### Surge Protection:

4kV

#### Dimming Driver:

Driver includes dimming control for 0-10V dimming systems. Requires separate 0-10V DC dimming circuit. Dims as low as 10%.

### Construction

#### Ambient Temperature:

Suitable for use in 40°C ambient temperatures.

### Cold Weather Starting:

The minimum starting temperature is -40°C/-40°F

### Thermal Management:

Cast aluminum patent pending Thermal Management system for optimal heat sinking. The HSLED is designed for cool operation, most efficient output and maximum LED life by minimizing LED junction temperature.

### Housing:

Precision die-cast aluminum housing, hood and mounting arm.

### Gaskets:

High Temperature Silicone.

### Finish:

Our environmentally friendly polyester powder coatings are formulated for high-durability and long-lasting color, and contains no VOC or toxic heavy metals.

### Green Technology:

Mercury and UV free. RoHS compliant components. Polyester powder coat finish formulated without the use of VOC or toxic heavy metals.

### Other

#### Warranty:

RAB warrants that our LED products will be free from defects in materials and workmanship for a period of five (5) years from the date of delivery to the end user, including coverage of light output, color stability, driver performance and fixture finish.

#### California Title 24:

HSLED13 complies with 2013 California Title 24 building and electrical codes as a commercial outdoor non-pole-mounted fixture < 30 Watts when used with a photosensor control. Select catalog number PCS900(120V) or PCS900/277 to order a photosensor.

## Technical Specifications (continued)

### Other

#### Patents:

The design of the HSLED is protected by Taiwan Patent 01510965 and patents pending in US, Canada, China, and Mexico.

#### Country of Origin:

Designed by RAB in New Jersey and assembled in the USA by RAB's IBEW Local 3 workers.

#### Buy American Act Compliant:

This product is a COTS item manufactured in the United States, and is compliant with the Buy American Act.

#### Recovery Act (ARRA) Compliant:

This product complies with the 52.225-21 "Required Use of American Iron, Steel, and Manufactured Goods-- Buy American Act-- Construction Materials (October 2010).

#### Trade Agreements Act Compliant:

This product is a COTS item manufactured in the United States, and is compliant with the Trade Agreements Act.

#### GSA Schedule:

Suitable in accordance with FAR Subpart 25.4.

## Dimensions

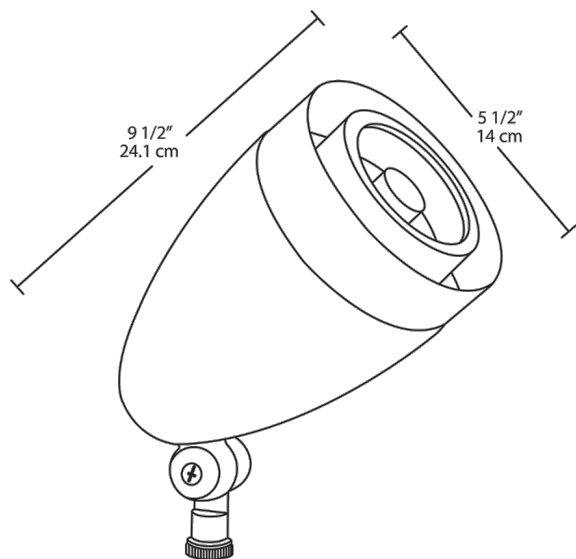

## Features

- Spot lighting for over 40 feet away
- Perfect for flag lighting
- NEMA type - 2H x 2V
- Available in four colors
- 100,000-hour life based on LM-80 tests
- 5- year LED warranty