



The LED undercabinet that replaces fluorescent fixtures.

Color: Brown

Weight: 0.7 lbs

Project:

Type:

Prepared By:

Date:

Driver Info

Type: Constant Current
 120V: 0.04A
 208V: N/A
 240V: N/A
 277V: N/A
 Input Watts: 4W
 Efficiency: N/A

LED Info

Watts: 5W
 Color Temp: 3000K
 Color Accuracy: 95 CRI
 L70 Lifespan: 50000
 Lumens: 270
 Efficacy: 65 LPW

Technical Specifications

Listings

UL Listing:

Suitable for damp locations.

ENERGY STAR® V2.0:

This product is ENERGY STAR® V2.0 qualified.

IESNA LM-79 & LM-80 Testing:

RAB LED luminaires have been tested by an independent laboratory in accordance with IESNA LM-79 and LM-80, and have received the Department of Energy "Lighting Facts" label.

Electrical

Driver:

Constant Current, Class 2, 60 Hz, 120V: 0.04A

THD:

22.7% at 120V

Power Factor:

90.8% at 120V

LED Characteristics

LEDs:

Long-life, high-efficiency surface mount LEDs

Lifespan:

50,000-hour LED lifespan based on IES LM-80 results and TM-21 calculations.

Color Stability:

LED color temperature is warranted to shift no more than 200K in CCT over a 5 year period.

Color Uniformity:

RAB's range of CCT (Correlated Color Temperature) follows the guidelines of the American National Standard for Specifications for the Chromaticity of Solid State Lighting (SSL) Products, ANSI C78.377-2011.

Construction

Maximum Ambient Temperature:

Suitable for use in 40°C (104°F) ambient temperatures

Housing:

Die-formed steel with injection-molded endcaps

Lens:

Frosted polycarbonate diffusion lens

Mounting:

Undercabinet surface

Green Technology:

Mercury and UV free. RoHS compliant components. Polyester powder coat finish formulated without the use of VOC or toxic heavy metals.

Finish:

Our environmentally friendly polyester powder coatings are formulated for high-durability and long-lasting color, and contains no VOC or toxic heavy metals.

Other

Warranty:

RAB warrants that our LED products with special corrosion resistant powder coat finish will be free from defects in materials and workmanship for a period of five (5) years from the date of delivery to the end user, including coverage of light output, color stability, driver performance and fixture finish in corrosive environments up to C5-M classification.

Dimensions

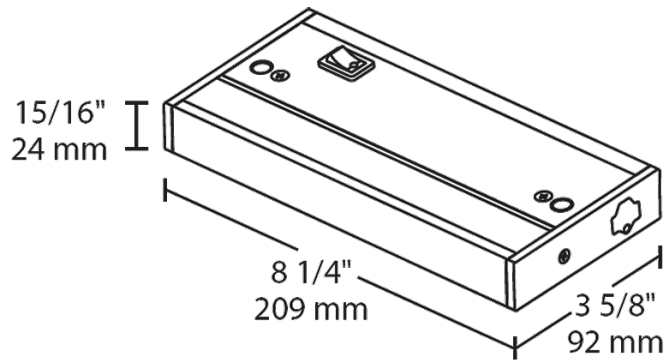

Features

- Simple to connect multiple fixtures
- Designed to provide soft, uniform lighting on work surfaces
- Compatible with common ELV & TRIAC dimmers

Ordering Matrix

Family	Length	Color Temp	Finish
KNOOK	8	Y	
	32 = 32"	Y = 3000K (Warm)	Blank = Bronze
	24 = 24"	YY = 2700K (Residential Warm)	W = White
	16 = 16"		
	8 = 8"		