

product

Compact 4 Watt LED floodlight works with 12V AC lighting systems. Perfectly suited for small-scale landscape lighting applications.

Color: Bronze

Weight: 1.5 lbs

Project:

Type:

Prepared By:

Date:

Driver Info

Type: Constant Current
 120V: N/A
 208V: N/A
 240V: N/A
 277V: N/A
 Input Watts: 5W
 Efficiency: 86%

LED Info

Watts: 4W
 Color Temp: 4000K
 Color Accuracy: 82 CRI
 L70 Lifespan: 100000
 Lumens: 433
 Efficacy: 93 LPW

Technical Specifications

Listings

UL Listing:

Suitable for wet locations. Suitable for ground mounting.

Electrical

Driver:

Class 2, 50/60 Hz, 12VAC Max, 0.5A

Voltage:

12V AC

Optical

NEMA Type:

NEMA Beam Spread of 4H x 4V

Spot Lens:

Optional spot lens enables a tool-less conversion to a NEMA Type 3H x 3V. Great for accent lighting or grazing buildings for an artistic touch.

Narrow Spot Lens:

Optional narrow spot lens enables a tool-less conversion to a NEMA Type 3H x 2V. Great for accent lighting or grazing buildings for an artistic touch.

Construction

Lens:

Microprismatic diffuser produces a smooth distribution and low glare.

Cold Weather Starting:

Minimum starting temperature is -40°F/-40°C.

Maximum Ambient Temperature:

Suitable for use in 40°C (104°F) ambient temperatures

Thermal Management:

Optimized using computational fluid dynamics software to ensure long LED and driver lifespan.

Housing:

Precision die-cast aluminum housing, lens frame and mounting arm.

Gasket:

High temperature silicone.

Finish:

Our environmentally friendly polyester powder coatings are formulated for high-durability and long-lasting color, and contains no VOC or toxic heavy metals.

Green Technology:

Mercury and UV free. RoHS compliant components. Polyester powder coat finish formulated without the use of VOC or toxic heavy metals.

LED Characteristics

Lifespan:

100,000-hour LED lifespan based on IES LM-80 results and TM-21 calculations

LED:

Multi-chip, high-output, long-life LED

Color Consistency:

4-step MacAdam Ellipse binning to achieve consistent fixture-to-fixture color.

Color Stability:

LED color temperature is warranted to shift no more than 200K in CCT over a 5 year period.

Color Uniformity:

RAB's range of CCT (Correlated Color Temperature) follows the guidelines of the American National Standard for (SSL) Products, ANSI C78.377-2015.

Other

Equivalency:

The LFLED4LV is equivalent in delivered lumens to a 35W MR16.

Wiring:

30" SPT1 zip cord included. Transformers provided by others.

Warranty:

RAB warrants that our LED products will be free from defects in materials and workmanship for a period of five (5) years from the date of delivery to the end user, including coverage of light output, color stability, driver performance and fixture finish.

California Title 24:

LFLED4LV complies with 2013 California Title 24 building and electrical codes as a commercial outdoor non-pole-mounted fixture < 30 Watts when used with a photosensor control. Select catalog number PCS900(120V) or PCS900/277 to order a photosensor.

Patents:

The design of the LFLED is protected by Taiwan Patent 01510966 and pending patents in US, Canada, China, and Mexico.

Dimensions

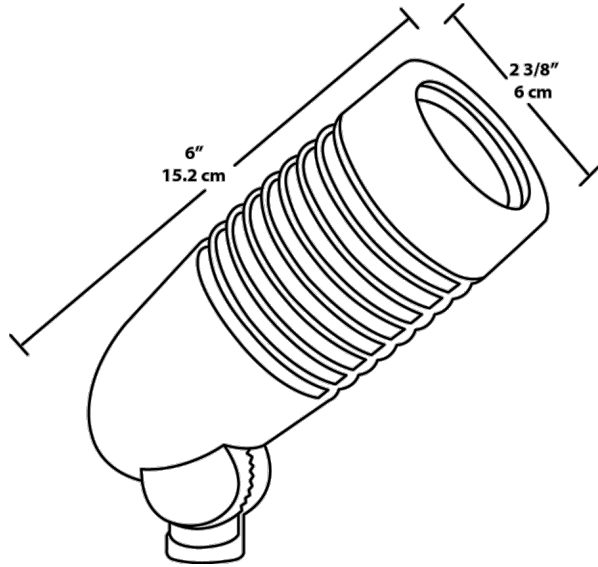

Features

- Works with existing 12V AC landscape lighting systems
- Replaces 35W MR16 halogen
- Reduces energy consumption by 85%
- Optional spot and narrow spot reflector kits available
- 100,000-Hour LED lifespan

Ordering Matrix

Family	Watts	Color Temp	Type	Finish
LFLED	4 = 4W	Blank = 5000K (Cool) Y = 3000K (Warm) N = 4000K (Neutral)	LV = Low Voltage	A = Bronze B = Black VG = Verde Green W = White