



Rugged die cast aluminum 6" diameter housings. Threaded, gasketed clear glass globe for durable weatherproofing and easy relamping. 1" long, 1/2" threaded nipple included for easy mounting. 75 Watt max. Incandescent lamp not supplied. Fluorescent lamp supplied.

Color: Black

Weight: 2.0 lbs

Project:	Type:
Prepared By:	Date:

Lamp Info		Ballast Info	
Type:	A-19	Type:	N/A
Watts:	75W	120V:	N/A
Shape/Size:	N/A	208V:	N/A
Base:	N/A	240V:	N/A
ANSI:	N/A	277V:	N/A
Hours:	750	Input Watts:	0W
Lamp Lumens:	1,220		
Efficacy:	N/A		

Technical Specifications

Listings

UL Listing:

Suitable for wet locations. Suitable for mounting within 4 feet of the ground.

Electrical

Socket:

Medium base porcelain with all copper electrical parts and 20" leads, including a ground lead.

Voltage:

120 volts AC

Construction

Globes:

Threaded, gasketed globe protects against weather, garden sprinklers and insects. Clear glass GL 100 globes standard for 4 Tier. Clear glass GL60 globes standard for 3 Tier. GL100 white globes also available for attractive appearance and glare reduction.

Housing:

Die cast aluminum housing with powder coat finish.

Mounting Stem:

Optional 12" mounting stem with 1/2" threads on both ends available .

Optical

Lamp:

Incandescent lamp not supplied. Medium base A-19 lamps, 120V. 75 watt max.

Dimensions

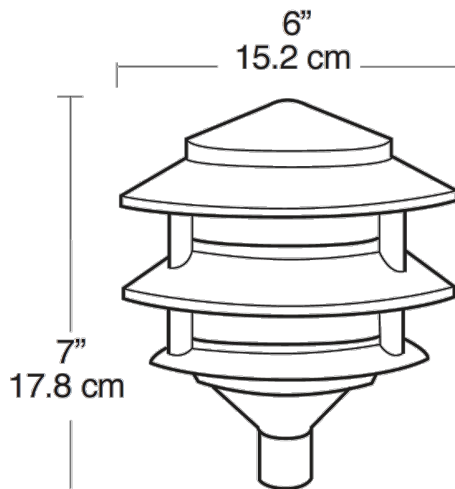

Features

- Rugged die cast aluminum housing with durable powder coating
- Socket with all copper electrical parts and 20" leads
- Quick and secure installation with one corrosionproof screw
- Threaded, gasketed globes for durable weatherproofing and easy relamping
- 12" color matched mounting stem with 1/2" threads available
- Includes easy mounting 1/2" threaded nipple