



Specification grade area lights available in IES Type II distributions. For use in parking lots, roadways, pathways and general area lighting. Best-in-class 5-G vibration rating. 5-year warranty.

Color: White

Weight: 20.9 lbs

Project:	Type:
Prepared By:	Date:

Driver Info		LED Info	
Type:	Constant Current	Watts:	65W
120V:	0.55A	Color Temp:	5000K
208V:	0.33A	Color Accuracy:	72 CRI
240V:	0.29A	L70 Lifespan:	100000
277V:	0.25A	Lumens:	7,207
Input Watts:	66W	Efficacy:	110 LPW
Efficiency:	99%		

Technical Specifications

Listings

UL Listing:

Suitable for wet locations.

IESNA LM-79 & IESNA LM-80 Testing:

RAB LED luminaires have been tested by an independent laboratory in accordance with IESNA LM-79 and 80, and have received the Department of Energy "Lighting Facts" label.

Electrical

Driver:

Constant Current, Class 2, 100-277V, 50/60 Hz, 120V: 0.55A, 208V: 0.33A, 240V: 0.29A, 277V: 0.25A

THD:

7% at 120, 10.3% at 277V

Power Factor:

99.6% at 120V, 95.4% at 277V

Dimming Driver:

Driver includes dimming control wiring for 0-10V dimming systems. Requires separate 0-10V DC dimming circuit. Dims as low as 10%.

Surge Protection:

L-N 4kV; L-L, L-GND 6kV

Optical

Lifespan:

100,000-hour LED lifespan based on IES LM-80 results and TM-21 calculations.

Full Cutoff:

Full cutoff optics conform with dark sky requirements.

Construction

IES Classification:

The Type II distribution is meant for lighting large areas, located by the roadside. Typically found on wide walkways, on ramps, entrance roadways and bike paths.

Effective Projected Area:

EPA = 0.8

Vibration Rating:

Industry-leading 5G vibration rating per ANSI C136.31.

Cold Weather Starting:

Minimum starting temperature is -40° F (-40° C)

Ambient Temperature:

Suitable for use in 104° F (40° C) ambient temperatures.

Housing:

Precision die-cast aluminum housing.

Mounting:

Mounts to RAB square poles. Mounts to all square and round poles if optional Universal Pole Adaptor is used.

Lens:

Clear acrylic lens with integrated optics

IP Rating:

Ingress Protection rating of IP66 for dust and water

Gaskets:

High temperature silicone gaskets.

Finish:

Formulated for high-durability and long lasting color.

Green Technology:

Mercury and UV free. RoHS compliant components. Polyester powder coat finish formulated without the use of VOC or toxic heavy metals.

LED Characteristics

LEDs:

Long-life, high-efficiency surface mount LEDs

Color Stability:

LED color temperature is warranted to shift no more than 200K in CCT over a 5 year period.

Color Uniformity:

RAB's range of CCT (Correlated Color Temperature) follows the guidelines of the American National Standard for Specifications for the Chromaticity of Solid State Lighting (SSL) Products, ANSI C78.377-2015.

Other

5 Yr Limited Warranty:

Fixture operation and paint finish are covered for a period of 5 years.

Replacement:

Replaces 150W Metal Halide.

Technical Specifications (continued)

<p>Other</p> <hr/> <p>Country of Origin: Designed by RAB in New Jersey and assembled in the USA by RAB's IBEW Local 3 workers.</p> <p>Buy American Act Compliant: This product is a COTS item manufactured in the United States, and is compliant with the Buy American Act.</p> <p>Recovery Act (ARRA) Compliant: This product complies with the 52.225-21 "Required Use of American Iron, Steel, and Manufactured Goods-- Buy American Act-- Construction Materials (October 2010).</p> <p>GSA Schedule: Suitable in accordance with FAR Subpart 25.4.</p> <p>Sensor Specifications</p> <hr/> <p>Operating Voltage: 120V or 277V</p> <p>Power Consumption: 1W</p> <p>0-10V Sinking Current: 50mA</p>	<p>Adjustable High and Low Modes: High: 0-10V; Low: off, 0-9.8V</p> <p>Time Delay: 30 seconds, 1-30 minutes</p> <p>Adjustable Cut Off Delay: Time in which the fixture will remain on low mode with no motion before turning off and waiting for new motion to turn on: None, 1 -60 min., 1 -5 hrs.</p> <p>Adjustable Sensitivity: None, low, medium, maximum</p> <p>Adjustable Setpoint: None, 1 to 250 fc, auto</p> <p>Adjustable Ramp Up and Fade Down Times: 1 to 60 sec.</p> <p>Operating Temperature: -40°F to 167°F (-40°C to +75°C)</p>	<p>Operating Humidity: 20% to 90% noncondensing</p> <p>Relay Life Rating: 200,000 cycles (120/277VAC), 50,000 cycles (230VAC)</p> <p>IP Rating: Ingress Protection rating of IP66 for dust and water</p> <p>UL Listing: Suitable for Wet Locations as factory installed.</p> <p>Handheld Wireless Configuration Tool: Adjust settings using handheld wireless configuration tool. Only available with 0-10V dimming driver options.</p> <p>Multi Level Motion Sensor: 60 ft. diameter coverage from 40 ft. height.</p>
---	--	--

Dimensions

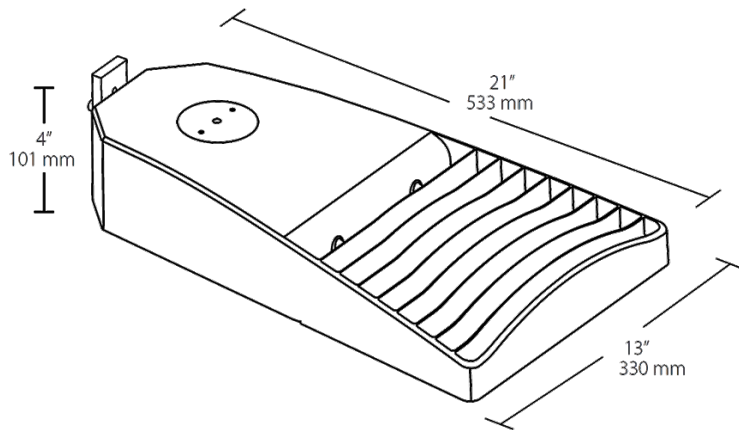

Features

- Lightweight design and low EPA minimize pole load
- Best-in-class 5-G vibration rating
- 100,000-hour LED lifespan
- 5-year warranty

Ordering Matrix

Family	IES Type	Wattage	Color Temp	Finish	Driver Options	Mounting	Sensor Options	Accessories
LOT	2T	65		W	/D10		/WS4	
	2T = Type II	160 = 160W 110 = 110W 65 = 65W	Blank = 5000K (Cool) N = 4000K (Neutral) Y = 3000K (Warm)	Blank = Bronze W = White	/D10 = 120-277V, 0-10V Dimming (standard) /480/D10 = 480V, 0-10V Dimming	Blank = Mounts to RAB square poles /UPA = Universal Pole Adaptor	Blank = None /PCT = 120-277V Twistlock PC /PCT4 = 480V Twistlock PC /WS2 = Wattstopper Sensor + 20ft lens, 120-277V /WS4 = Wattstopper Sensor + 40ft lens, 120-277V /5PR = 5-Pin Receptacle, no PCT /7PR = 7-Pin Receptacle, no PCT /BL = Bi-Level Dimming, 120-277V	Blank = None /HS = 2 House-Side-Shields