



Specification grade area lights available in IES Type II distributions. For use in parking lots, roadways, pathways and general area lighting. Best-in-class 5-G vibration rating. 5-year warranty.

Color: Bronze

Weight: 20.9 lbs

<b>Project:</b>	<b>Type:</b>
<b>Prepared By:</b>	<b>Date:</b>

Driver Info		LED Info	
Type:	Constant Current	Watts:	65W
120V:	0.55A	Color Temp:	3000K
208V:	0.33A	Color Accuracy:	71 CRI
240V:	0.29A	L70 Lifespan:	100000
277V:	0.25A	Lumens:	6,666
Input Watts:	65W	Efficacy:	102 LPW
Efficiency:	99%		

**Technical Specifications**

**Listings**

**UL Listing:**

Suitable for wet locations.

**IESNA LM-79 & IESNA LM-80 Testing:**

RAB LED luminaires have been tested by an independent laboratory in accordance with IESNA LM-79 and 80, and have received the Department of Energy "Lighting Facts" label.

**Dark Sky Approved:**

Conforms to the requirements listed by the International Dark-Sky Association for "Dark Sky" approval. The Fixture Seal of Approval provides objective, third-party certification for luminaires that minimize glare, reduce light trespass, and don't pollute the night sky.

**Electrical**

**Driver:**

Constant Current, Class 2, 100-277V, 50/60 Hz, 120V: 0.55A, 208V: 0.33A, 240V: 0.29A, 277V: 0.25A

**THD:**

7% at 120, 10.3% at 277V

**Power Factor:**

99.6% at 120V, 95.4% at 277V

**Dimming Driver:**

Driver includes dimming control wiring for 0-10V dimming systems. Requires separate 0-10V DC dimming circuit. Dims as low as 10%.

**Surge Protection:**

L-N 4kV; L-L, L-GND 6kV

**Optical**

**Lifespan:**

100,000-hour LED lifespan based on IES LM-80 results and TM-21 calculations.

**Construction**

**IES Classification:**

The Type II distribution is meant for lighting large areas, located by the roadside. Typically found on wide walkways, on ramps, entrance roadways and bike paths.

**Effective Projected Area:**

EPA = 0.8

**Vibration Rating:**

Industry-leading 5G vibration rating per ANSI C136.31.

**Cold Weather Starting:**

Minimum starting temperature is -40° F (-40° C)

**Ambient Temperature:**

Suitable for use in 104° F (40° C) ambient temperatures.

**Housing:**

Precision die-cast aluminum housing.

**Mounting:**

Mounts to RAB square poles. Mounts to all square and round poles if optional Universal Pole Adaptor is used.

**Lens:**

Clear acrylic lens with integrated optics

**IP Rating:**

Ingress Protection rating of IP66 for dust and water

**Gaskets:**

High temperature silicone gaskets.

**Finish:**

Formulated for high-durability and long lasting color.

**Green Technology:**

Mercury and UV free. RoHS compliant components. Polyester powder coat finish formulated without the use of VOC or toxic heavy metals.

**For use on LEED Buildings:**

IDA Dark Sky Approval means that this fixture can be used to achieve LEED Credits for Light Pollution Reduction.

**LED Characteristics**

**LEDs:**

Long-life, high-efficiency surface mount LEDs

**Color Stability:**

LED color temperature is warranted to shift no more than 200K in CCT over a 5 year period.

**Color Uniformity:**

RAB's range of CCT (Correlated Color Temperature) follows the guidelines of the American National Standard for Specifications for the Chromaticity of Solid State Lighting (SSL) Products, ANSI C78.377-2015.

**Other**

**5 Yr Limited Warranty:**

Fixture operation and paint finish are covered for a period of 5 years.

**Technical Specifications (continued)**

**Other**

**Replacement:**

Replaces 150W Metal Halide.

**Country of Origin:**

Designed by RAB in New Jersey and assembled in the USA by RAB's IBEW Local 3 workers.

**Buy American Act Compliant:**

This product is a COTS item manufactured in the United States, and is compliant with the Buy American Act.

**Recovery Act (ARRA) Compliant:**

This product complies with the 52.225-21 "Required Use of American Iron, Steel, and Manufactured Goods-- Buy American Act-- Construction Materials (October 2010).

**GSA Schedule:**

Suitable in accordance with FAR Subpart 25.4.

**Sensor Specifications**

**Operating Voltage:**

120V or 277V

**Power Consumption:**

1W

**0-10V Sinking Current:**

50mA

**Adjustable High and Low Modes:**

High: 0-10V; Low: off, 0-9.8V

**Time Delay:**

30 seconds, 1-30 minutes

**Adjustable Cut Off Delay:**

Time in which the fixture will remain on low mode with no motion before turning off and waiting for new motion to turn on: None, 1 -60 min., 1 -5 hrs.

**Adjustable Sensitivity:**

None, low, medium, maximum

**Adjustable Setpoint:**

None, 1 to 250 fc, auto

**Adjustable Ramp Up and Fade Down Times:**

1 to 60 sec.

**Operating Temperature:**

-40°F to 167°F (-40°C to +75°C)

**Operating Humidity:**

20% to 90% noncondensing

**Relay Life Rating:**

200,000 cycles (120/277VAC), 50,000 cycles (230VAC)

**IP Rating:**

Ingress Protection rating of IP66 for dust and water

**UL Listing:**

Suitable for Wet Locations as factory installed.

**Handheld Wireless Configuration Tool:**

Adjust settings using handheld wireless configuration tool. Only available with 0-10V dimming driver options.

**Multi Level Motion Sensor:**

60 ft. diameter coverage from 40 ft. height.

**Dimensions**

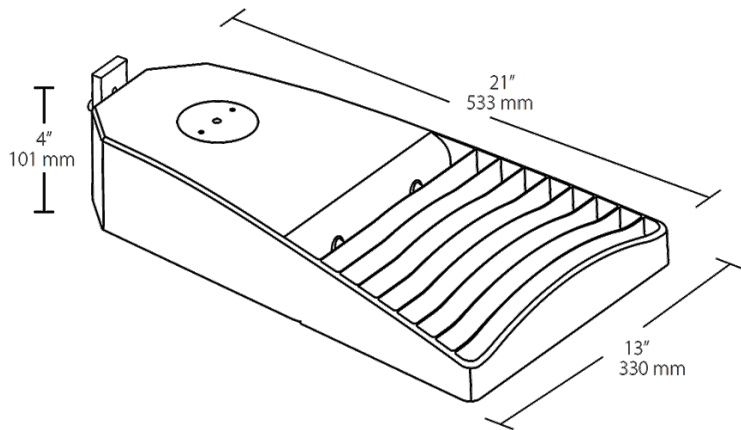

**Features**

- Lightweight design and low EPA minimize pole load
- Best-in-class 5-G vibration rating
- 100,000-hour LED lifespan
- 5-year warranty

## Ordering Matrix

Family	IES Type	Wattage	Color Temp	Finish	Driver Options	Mounting	Sensor Options	Accessories
LOT	2T	65	Y		/D10		/WS4	
	2T = Type II	160 = 160W 110 = 110W 65 = 65W	Blank = 5000K (Cool) N = 4000K (Neutral) Y = 3000K (Warm)	Blank = Bronze W = White	/D10 = 120-277V, 0-10V Dimming (standard) /480/D10 = 480V, 0-10V Dimming	Blank = Mounts to RAB square poles /UPA = Universal Pole Adaptor	Blank = None /PCT = 120-277V Twistlock PC /PCT4 = 480V Twistlock PC /WS2 = Wattstopper Sensor + 20ft lens, 120-277V /WS4 = Wattstopper Sensor + 40ft lens, 120-277V /5PR = 5-Pin Receptacle, no PCT /7PR = 7-Pin Receptacle, no PCT /BL = Bi-Level Dimming, 120-277V	Blank = None /HS = 2 House-Side-Shields