

Project:

Type:

Prepared By:

Date:



UPC: 019813510583



Features and Benefits

Produces rich and vibrant colors >90CRI

Energy efficient replacement for incandescent and halogen Small diameter reflectors

Constructed from durable materials which lowers risk of breakage

Rated for use in enclosed and open fixtures in dry or damp locations

Single optic and full face lens for precise beam angle control

Longer lifespan compared to legacy equivalents minimizes replacement and maintenance costs

Title 20 Compliant, ENERGY STAR Compliant, UL Listed

Compatible with low voltage transformers (check compatibility list)

Technical Specifications

Performance

Product Type:

Small-Reflector

Input Wattage:

7.5W

Typical Lumen Output:

560

Efficacy:

75 lm/W

Color Temperature:

3000K Warm White

CRI:

≥90

L70 Lifespan:

25,000 Hours

Dimmable:

Yes

Construction

Bulb Shape:

MR16

Base Type:

GU5.3

Beam Angle:

15°

Other

Equivalency:

75W Halogen

Warranty (Years):

RAB warrants that our LED products will be free from defects in materials and workmanship for a period of five (5) years from the date of delivery to the end user, including coverage of light output, color stability, driver performance and fixture finish. RAB's warranty is subject to all terms and conditions found at rablighting.com/warranty.

Electrical

Power Factor:

>0.9

Operating Temperature:

-20°C - 45°C

Input Voltage:

12V

Technical Specifications (continued)

Technical Specifications

For Use Outdoors in Open Fixtures:

No

Electrical Characteristics

Flicker:

≤30%

Compliance

UL Listed:

Yes

ENERGY STAR V2.0:

This product is ENERGY STAR® Version 2.0 Certified

Energy Star ID:

2351638

Model Number:

R10031

CEC Status:

Lawful for sale in California

Case and Pallet Dimensions

	QTY	LENGTH (in)	WIDTH (in)	HEIGHT (in)
CASE	12	8.74	6.61	2.165
PALLET	5760	44.49	40.47	45.35

Dimension

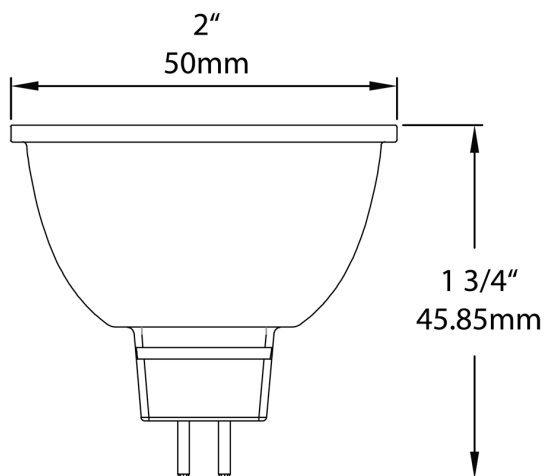

Light Distribution

