

NDLED6SD-80YYHC-S-W



High-performance LED downlight module for use with RAB new construction rough-in. Microprismatic diffusion lens optimizes lumen output and delivers smooth, uniform illumination that enhances any space.

Color: Specular silver cone white trim

Weight: 2.0 lbs

Project:	Type:
Prepared By:	Date:

Driver Info		LED Info	
Type:	See Rough-in*	Watts:	20W or 26W*
120V:	See Rough-in*	Color Temp:	2700K
208V:	See Rough-in*	Color Accuracy:	90 CRI
240V:	See Rough-in*	L70 Lifespan:	100000
277V:	See Rough-in*	Lumens:	20W:1448* 26W:1913*
Input Watts:	See Rough-in*	Efficiency:	N/A
Efficiency:	N/A		

Technical Specifications

Listings

UL Listed:

Suitable for wet locations covered ceiling.

ENERGY STAR:

This product is ENERGY STAR® qualified.

Optical

Photometrics:

Photometrics are based on prorated reports. Contact the RAB Lighting Design department for the most up-to-date data.

Optics:

80° beam spread with specular thermoplastic optics and Nanostructure lens technology for smooth light output and high efficiency.

Construction

Trim Component:

This component must be ordered with New Construction Square Rough-In in order to make a complete fixture.

Housing:

Professional-grade, die-cast aluminum construction.

Trim Ring:

White powder coated die cast trim ring.

Trim Cone:

Specular silver square trim cone.

Drop Ceiling Installation:

NDLED can be installed in drop ceiling tiles when using optional c-channel bars and following local construction codes.

Aperture Size:

6" Trim Module.

Easy Installation:

The EZ-Connector makes installation easy.

Junction Box:

Integral junction box with wiring capacity for Min 90°C supply conductors
4 in 4 out

Electrical

Dimming:

Dimmable. Requires rough-in with dimming driver.

Dimming Driver:

0 - 10V (at 120-277V), TRIAC and ELV (at 120V only).

Other

Air Tight:

Housing certified Air Tight as per ASTM E283

California Title 24:

NDLED6S complies with 2013 California Title 24 building and electrical codes as a residential indoor fixture and commercial indoor fixture for general spaces.

Warranty:

RAB warrants that our LED products will be free from defects in materials and workmanship for a period of five (5) years from the date of delivery to the end user, including coverage of light output, color stability, driver performance and fixture finish.

Country of Origin:

Designed by RAB in New Jersey and assembled in the USA by RAB's IBEW Local 3 workers.

Buy American Act Compliant:

This product is a COTS item manufactured in the United States, and is compliant with the Buy American Act.

Recovery Act (ARRA) Compliant:

This product complies with the 52.225-21 "Required Use of American Iron, Steel, and Manufactured Goods-- Buy American Act-- Construction Materials (October 2010).

Trade Agreements Act Compliant:

This product is a COTS item manufactured in the United States, and is compliant with the Trade Agreements Act.

GSA Schedule:

Suitable in accordance with FAR Subpart 25.4.

LED Characteristics

Color Consistency:

3-step MacAdam Ellipse binning to achieve consistent fixture-to-fixture color.

NDLED6SD-80YYHC-S-W

Dimensions

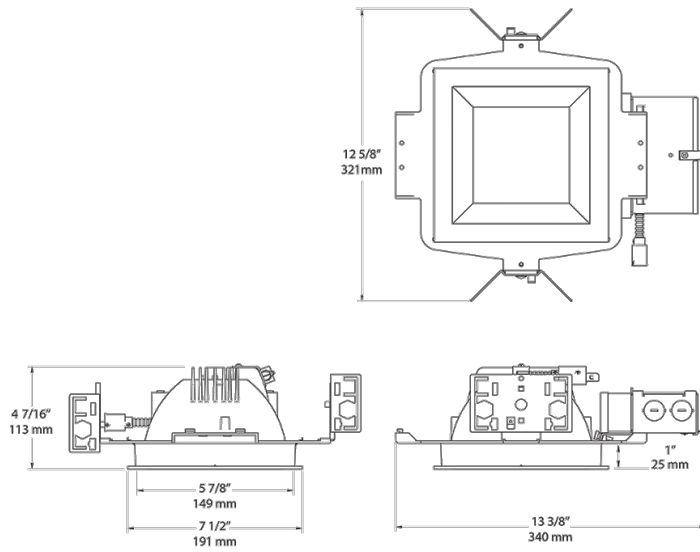

Features

- Butterfly bracket allows mounting with bar stock, "C" channel, 1/2" conduit or nailer bars
- Low-profile design allows for installation in ceilings with limited space
- Absolute White 3-step consistency and black body accurate
- Nanostructure lens eliminates "hot spots" providing smooth and efficient light
- Available with 82 or 92 CRI

Ordering Matrix

Family	Size	Shape	Driver	Beam Spread	Color Temp	CRI	Cone Color	Trim Color
NDLED	6	S	D	80	YY	HC	S	W
6 = 6"		S = Square	D = Universal Dimming	50 = 50° 80 = 80° W = Wall Washer	YY = 2700K (Residential Warm) Y = 3000K (Warm) YN = 3500K (Warm Neutral) N = 4000K (Neutral)	Blank = 82 CRI HC = 92 CRI	S = Silver M = Matte Silver W = White B = Black	S = Silver W = White B = Black