

High-end, new construction LED downlights in 7" make installation a breeze when you're framing out a space from the ground up or when you have access from the top of the ceiling.

Color: White

Weight: 8.0 lbs

Project:

Type:

Prepared By:

Date:

Driver Info

Type:	Constant Current
120V:	0.31A
208V:	0.19A
240V:	0.17A
277V:	0.14A
Input Watts:	0W
Efficiency:	N/A

LED Info

Watts:	38W
Color Temp:	4000K
Color Accuracy:	92 CRI
L70 Lifespan:	100000
Lumens:	N/A
Efficacy:	N/A

Technical Specifications

Lightcloud

Lightcloud Installed:

Lightcloud is a commercial wireless lighting control system and service fully developed and supported by RAB. It's powerful and flexible, yet easy to use and install.

Listings

UL Listed:

Suitable for wet locations in a covered ceiling

IESNA LM-79 & LM-80 Testing:

RAB LED luminaires have been tested by an independent laboratory in accordance with IESNA LM-79 and LM-80, and have received the Department of Energy "Lighting Facts" label.

Optical

Photometrics:

Photometrics are based on prorated reports. Contact the RAB Lighting Design department for the most up-to-date data.

Electrical

Driver:

Class 2, Constant Current, 50-60Hz, 900mA

Dimming:

Universal dimming driver for 0-10V (at 120-277V), TRIAC or ELV (at 120V only).

Surge Protection:

6kV

Construction

Housing Component:

This component must be ordered with New Construction Downlights Trim Module in order to make a complete fixture.

Housing:

Formed galvanized steel construction

Lens:

Diffusion lens for smooth and even light distribution

Reflector:

Spun aluminum

Heat Sink:

Die-cast aluminum with external fins for maximum heat dissipation

Finish:

Formulated for high-durability and long lasting color.

Green Technology:

Mercury and UV free. RoHS compliant components. Polyester powder coat finish formulated without the use of VOC or toxic heavy metals.

LED Characteristics

Lifespan:

100,000-hour LED lifespan based on IES LM-80 results and TM-21 calculations.

LEDs:

Long-life, high-efficiency surface mount LEDs with 3 step binning

Color Consistency:

3-step MacAdam Ellipse binning to achieve consistent fixture-to-fixture color.

Replacement:

Replaces 50 Watt Metal Halide and 32 Watt CFL.

Other

Warranty:

RAB warrants that our LED products will be free from defects in materials and workmanship for a period of ten (10) years from the date of delivery to the end user, including coverage of light output, color stability, driver performance and fixture finish.

Dimensions

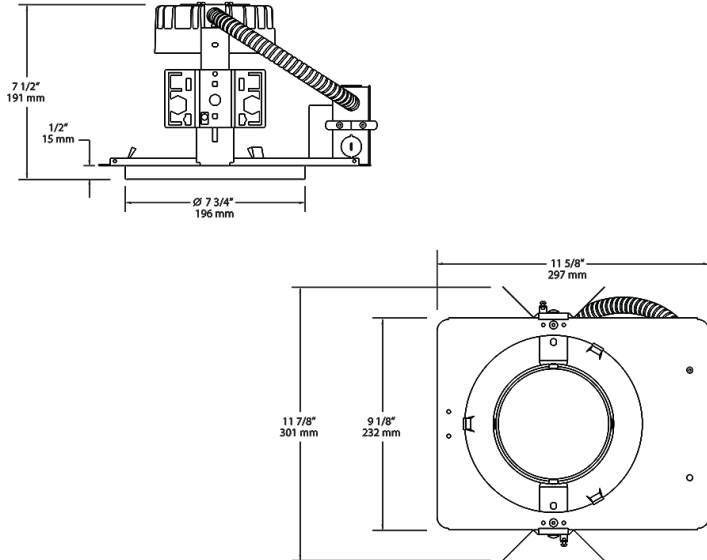

Features

- Universal driver is compatible with TRIAC, ELV and 0-10V dimmers
- Lightweight design for easy installation and increased safety
- 100,000-Hour LED lifespan

Ordering Matrix

Family	Size	Shape	Watts	Color Temp	CRI	Lightcloud
NDLED	7	R	38	N	HC	/LC
	7 = 7"	R = Round	30 = 30W 38 = 38W	YY = 2700K (Residential Warm) Y = 3000K (Warm) YN = 3500K (Warm Neutral) N = 4000K (Neutral)	Blank = 82 CRI HC = 92 CRI	Blank = No Lightcloud /LC = Lightcloud