



LED High Bay fixture ideal for large indoor spaces, including warehouses, gymnasiums and distribution centers that require mounting heights from 15 to 50 feet. Available in 95, 150, 185 and 225 Watt versions with equivalencies from 200 to 400 Watt metal halide fixtures.

Color: White

Weight: 25.4 lbs

Project:	Type:
Prepared By:	Date:

Driver Info		LED Info	
Type:	Constant Current	Watts:	225W
120V:	N/A	Color Temp:	3500K
208V:	N/A	Color Accuracy:	82 CRI
240V:	N/A	L70 Lifespan:	100000
277V:	N/A	Lumens:	24,005
Input Watts:	222W	Efficacy:	108 LPW
Efficiency:	N/A		

Technical Specifications

Listings

UL Listing:

Suitable for damp locations

IESNA LM-79 & LM-80 Testing:

RAB LED luminaires have been tested by an independent laboratory in accordance with IESNA LM-79 and LM-80, and have received the Department of Energy "Lighting Facts" label.

LED Characteristics

Lifespan:

100,000-hour LED lifespan based on IES LM-80 results and TM-21 calculations.

LEDs:

Long-life, high-efficiency surface mount LEDs

Color Stability:

LED Color temperature is warranted to shift no more than 200K in CCT over a 5 year period.

Color Uniformity:

RAB's range of CCT (Correlated Color Temperature) follows the guidelines of the American National Standard for Specifications for the Chromaticity of Solid State Lighting (SSL) Products, ANSI C78.377-2011.

Electrical

Drivers:

Two Drivers, Class 2, Constant Current, 347-480VAC, 50-60Hz, 4kV

THD:

13.8% at 480V

Power Factor:

92.5% at 480V

Construction

Ambient Temperature:

Suitable for use 12 hours a day, 5 days a week in 50°C. Suitable for 24/7 use in ambient temperatures up to 30°C. For questions related to fixture operation in high ambient temperatures, contact RAB tech support at 888-722-1000.

Housing:

Extruded aluminum

Lens:

High-transmittance polystyrene

Reflector:

Specular, high-reflectance aluminum with 95% reflectivity

Mounting:

3/4" NPS for pendant mount (pendant by others) or direct surface knockout on junction box for mounting to ceiling. Mounting hardware (not provided) should be suitable to mounting surface.

Gaskets:

High temperature silicone gaskets.

Finish:

Our environmentally friendly polyester powder coatings are formulated for high-durability and long-lasting color, and contains no VOC or toxic heavy metals.

Green Technology:

Mercury and UV free. RoHS compliant components. Polyester powder coat finish formulated without the use of VOC or toxic heavy metals.

Recommended Mounting Height:

Up to 50 ft.

Other

Equivalency:

RAIL High Bay 225W LED is equivalent to 400W metal halide fixtures at 40' mounting height.

Warranty:

RAB warrants that our LED products will be free from defects in materials and workmanship for a period of five (5) years from the date of delivery to the end user, including coverage of light output, color stability, driver performance and fixture finish.

California Title 24:

See RAIL with Multi-Level sensor (/WS2 or /WS4) for a compliant California Title 24.

Country of Origin:

Designed by RAB in New Jersey and assembled in the USA by RAB's IBEW Local 3 workers.

Buy American Act Compliant:

This product is a COTS item manufactured in the United States, and is compliant with the Buy American Act.

Recovery Act (ARRA) Compliant:

This product complies with the 52.225-21 "Required Use of American Iron, Steel, and Manufactured Goods-- Buy American Act-- Construction Materials (October 2010).

Trade Agreements Act Compliant:

This product is a COTS item manufactured in the United States, and is compliant with the Trade Agreements Act.

GSA Schedule:

Suitable in accordance with FAR Subpart 25.4.

Dimensions

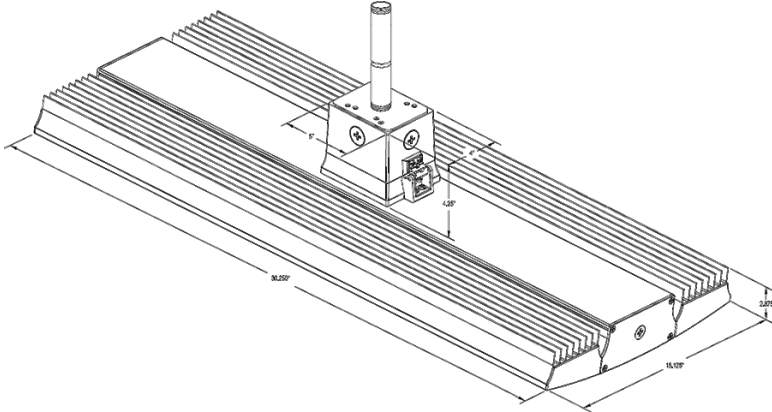

Features

- Ideal for large spaces
- Ultra-high efficacy
- Up to 60% less energy usage than equivalent metal halide fixtures
- 100,000 hour lifespan, virtually maintenance free operation
- Optional 0-10V driver for variable dimming down to 10%

Ordering Matrix

Family	Mount	Watts	Color Temp	Finish	Voltage	Dimming
RAIL						
	Blank = V Hooks P = Pendant or Surface	95 = 95W 150 = 150W 185 = 185W 225 = 225W	Blank = 5000K (Cool) YN = 3500K (Warm Neutral) N = 4000K (Neutral)	W = White	Blank = 120-277V /480 = 480V	Blank = No Dimming /D10 = Dimmable