



Clean, unobtrusive design delivers smooth and abundant light from an aperture just over 1 inch wide. Available in flush trim for a trimless look without the mess left behind from ceiling finishing work.

Color: White trim

Weight: 1.5 lbs

Project:

Type:

Prepared By:

Date:

Driver Info

Type:	Constant Current
120V:	0.08A
208V:	N/A
240V:	N/A
277V:	N/A
Input Watts:	9W
Efficiency:	90%

LED Info

Watts:	8W
Color Temp:	2700K
Color Accuracy:	82 CRI
L70 Lifespan:	N/A
Lumens:	568
Efficacy:	64 LPW

Technical Specifications

Listings

UL Listing:

Suitable for wet locations in a covered ceiling

ENERGY STAR:

This product is ENERGY STAR® qualified.

IESNA LM79 & LM-80 Testing:

RAB LED luminaires have been tested by an independent laboratory in accordance with IESNA LM-79 and LM-80, and have received the Department of Energy "Lighting Facts" label.

Construction

IC Rating:

Suitable for direct contact with insulation

Trim Component:

This component can be ordered with New Construction housing in order to make a complete fixture.

Ambient Temperature:

Suitable for use in 55°C ambient temperatures

Cold Weather Starting:

The minimum starting temperature is -40°F/-40°C

Lens:

Nanostructure lens eliminates "hot spots", and helps provide smooth, uniform light and higher efficiency

Junction Box:

Integral junction box with wiring capacity for
Min 60°C supply conductors
End of Run

Housing:

Specification-grade, die-cast aluminum construction

Installation:

Torsion springs easily install into ceiling collar (remodeler) or rough-in (new construction)

Trim Ring:

White powder coated die cast 1/2" trim ring.

Green Technology:

Mercury and UV free. RoHS compliant components. Polyester powder coat finish formulated without the use of VOC or toxic heavy metals.

Finish:

Our environmentally friendly polyester powder coatings are formulated for high-durability and long-lasting color, and contain no VOC or toxic heavy metals.

LED Characteristics

LED:

High-output, long-life LED with 2-step binning and integrated driver technology

Color Consistency:

2-step MacAdam Ellipse binning to achieve consistent fixture-to-fixture color

Color Stability:

LED color temperature is warrantied to shift no more than 200K in CCT over a 5 year period

Electrical

Driver:

Constant Current, Class 2, 120VAC Only, 50/60Hz, 200mA, 0.07A

Dimming Driver:

TRIAC and ELV (at 120V only).

Optical

Optics:

30° beam spread with specular thermoplastic optics

Spacing Criteria:

0-180° (along): 0.54
90-270° (across): 0.54
diagonal: 0.54

Other

Equivalency:

RDLED 8W is equivalent to 50W MR16

California Title 24:

RDLED2R8 complies with 2013 California Title 24 building and electrical codes as a commercial indoor fixture for general spaces when used with a vacancy sensor and TRIAC dimming control. Select a vacancy sensor using catalog number LVS800. TRIAC dimmer provided by others.

Warranty:

RAB warrants that our LED products will be free from defects in materials and workmanship for a period of ten (10) years from the date of delivery to the end user, including coverage of light output, color stability, driver performance and fixture finish.

Country of Origin:

Designed by RAB in New Jersey and assembled in the USA by RAB's IBEW Local 3 workers.

Buy American Act Compliant:

This product is a COTS item manufactured in the United States, and is compliant with the Buy American Act.

Technical Specifications (continued)

Other

Recovery Act (ARRA) Compliant:

This product complies with the 52.225-21 "Required Use of American Iron, Steel, and Manufactured Goods-- Buy American Act-- Construction Materials (October 2010)

Trade Agreements Act Compliant:

This product is a COTS item manufactured in the United States, and is compliant with the Trade Agreements Act.

GSA Schedule:

Suitable in accordance with FAR Subpart 25.4

Dimensions

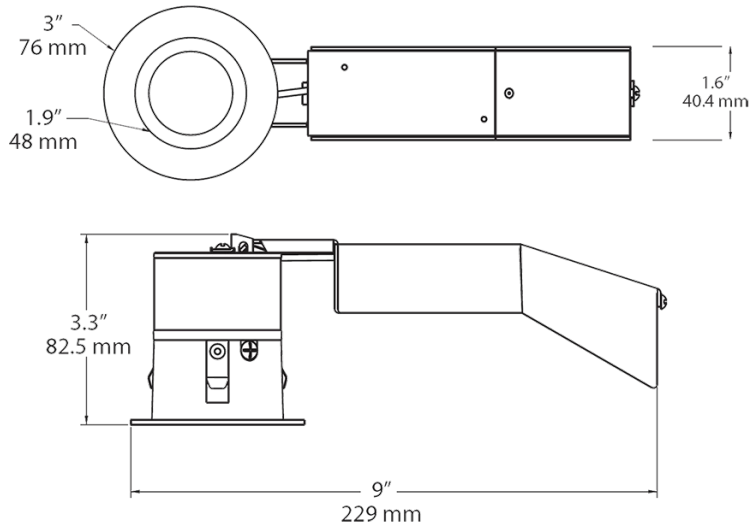

Features

8W replaces 50W MR16 with energy savings of 82%

TRIAC dimmer compatibility for additional light control

Precision-engineered optics deliver smooth light without hot spots or glare

Ordering Matrix

Family	Size	Shape	Watts	Beam Spread	Color Temp	CRI	Type	Finish
RDLED	2 = 2"	R = Round	8 = 8W	20 = 20° 30 = 30° 40 = 40° W = Wall Washer	YY = 2700K (Residential Warm) Y = 3000K (Warm) YN = 3500K (Warm Neutral) N = 4000K (Neutral)	Blank = 82 or 83 CRI HC = 90 CRI	T = 1/2" Trim TL = Trimless Look	W = White Trim