



Remodeler Round 4" & 6" Silver Trim with Black Cone downlights provide an ultra performance, high-end solution for adding recessed lighting to existing ceilings.

Color: Black cone silver trim

Weight: 2.0 lbs

<b>Project:</b>	<b>Type:</b>
<b>Prepared By:</b>	<b>Date:</b>

Driver Info		LED Info	
Type:	Constant Current	Watts:	26W
120V:	0.24A	Color Temp:	3000K
208V:	0.14A	Color Accuracy:	80 CRI
240V:	0.13A	L70 Lifespan:	100000
277V:	0.12A	Lumens:	1,638
Input Watts:	29W	Efficacy:	56 LPW
Efficiency:	89%		

## Technical Specifications

### Listings

#### UL Listed:

Suitable for wet locations covered ceiling.

### Optical

#### Photometrics:

Photometrics are based on prorated reports. Contact the RAB Lighting Design department for the most up-to-date data.

#### Optics:

50° beam spread with specular thermoplastic optics and Nanostructure lens technology for smooth light output and high efficiency.

### Electrical

#### Driver:

ELV, 0-10V and TRIAC Dimming, Constant Current, Class 2, 120V-277V, 50/60Hz, Power Factor 98%, THD ≤ 20%.

### LED Characteristics

#### LED:

Long-life, high-output LED module. Binned for natural white light to match incandescent and 3-step MacAdam Ellipse consistency.

#### Lifespan:

100,000-hour LED lifespan based on IES LM-80 results and TM-21 calculations.

#### Correlated Color Temp. (Nominal CCT):

3000 Warm.

#### Color Consistency:

3-step MacAdam Ellipse binning to achieve consistent fixture-to-fixture color.

#### Color Stability:

LED color temperature is warrantied to shift no more than 200K in CCT over a 5 year period.

### Construction

#### Ambient Temperature:

Suitable for use in 40°C ambient temperatures.

#### Cold Weather Starting:

The minimum starting temperature is -40°C/-40°F

#### Trim Ring:

Silver powder coated die cast trim ring.

#### Trim Cone:

Black round trim cone.

#### Lens:

Nanostructure lens eliminates "hot spots", and helps provide smooth, uniform light and higher efficiency.

#### Junction Box:

Integral junction box with wiring capacity for Min 90°C supply conductors 2 in 2 out

#### Housing:

Professional-grade, die-cast aluminum construction.

#### Easy Installation:

Easy installation with ceiling clamps.

#### Green Technology:

Mercury and UV free. RoHS compliant components. Polyester powder coat finish formulated without the use of VOC or toxic heavy metals.

### Other

#### Equivalency:

RDLED 26W is equivalent to 100W PAR.

#### Air Tight:

Housing certified Air Tight as per ASTM E283

#### Absolute White™:

A unique binning process designed to match incandescent at each color temperature. It's 3-step consistent, very stable over time and looks the way you expect light to look.

#### California Title 24:

RDLED6R26F complies with 2013 California Title 24 building and electrical codes as a residential indoor fixture. See RDLED models with dimming drivers for products that comply as commercial indoor fixtures for general spaces. Any additional component requirements will be listed in the Title 24 section under technical specifications on the product page.

#### Warranty:

RAB warrants that our LED products will be free from defects in materials and workmanship for a period of five (5) years from the date of delivery to the end user, including coverage of light output, color stability, driver performance and fixture finish.

#### Country of Origin:

Designed by RAB in New Jersey and assembled in the USA by RAB's IBEW Local 3 workers.

#### Buy American Act Compliant:

This product is a COTS item manufactured in the United States, and is compliant with the Buy American Act.

#### Recovery Act (ARRA) Compliant:

This product complies with the 52.225-21 "Required Use of American Iron, Steel, and Manufactured Goods-- Buy American Act-- Construction Materials (October 2010).

## Technical Specifications (continued)

### Other

#### Trade Agreements Act Compliant:

This product is a COTS item manufactured in the United States, and is compliant with the Trade Agreements Act.

### GSA Schedule:

Suitable in accordance with FAR Subpart 25.4.

## Dimensions

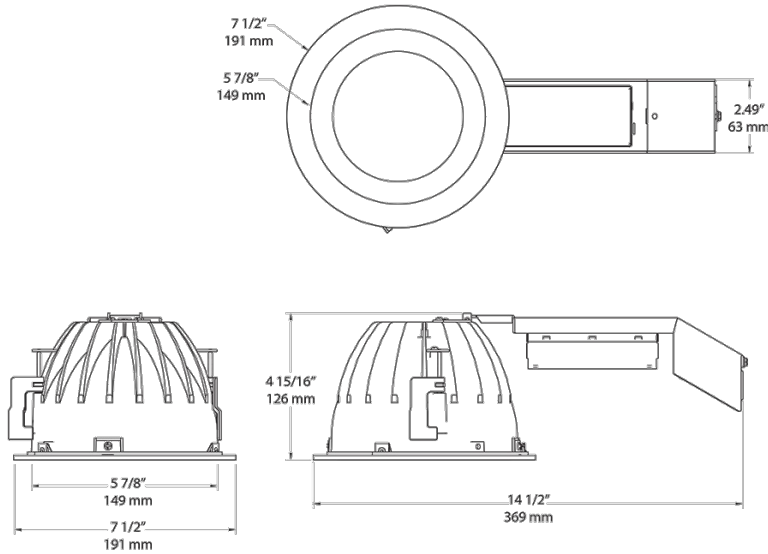

## Features

- High performance, high efficiency alternative to incandescent lighting
- Integrated ceiling clamps make installation fast and secure for ceiling up to 1 1/4" thick
- Nanostructure lens eliminates "hot spots" providing smooth and efficient light
- Low-profile design allows for installation in ceilings with limited space
- Absolute White™ natural light output

## Ordering Matrix

Family	Size	Shape	Watts	Driver Option	Beam Spread	Color Temp	CRI	Cone Color	Trim Color
RDLED									
	6 = 6"	R = Round	12 = 12W (4" only)	D = Universal Dimming	50 = 50° 80 = 80°	YY = 2700K (Residential Warm) Y = 3000K (Warm) YN = 3500K (Warm Neutral)	Blank = 82 CRI HC = 92 CRI	B = Black	S = Specular Silver
	4 = 4"		20 = 20W 26 = 26W (6" only)		W = Wall Washer				