



Remodeler Square 4" & 6" White Trim with White Cone downlights provide an ultra performance, high-end solution for adding recessed lighting to existing ceilings.

Color: White cone white trim

Weight: 2.0 lbs

<b>Project:</b>	<b>Type:</b>
<b>Prepared By:</b>	<b>Date:</b>

Driver Info		LED Info	
Type:	Constant Current	Watts:	20W
120V:	0.17A	Color Temp:	4000K
208V:	0.11A	Color Accuracy:	80 CRI
240V:	0.10A	L70 Lifespan:	100000
277V:	0.09A	Lumens:	1,779
Input Watts:	20W	Efficacy:	88 LPW
Efficiency:	99%		

## Technical Specifications

### Listings

#### UL Listed:

Suitable for wet locations covered ceiling.

#### ENERGY STAR:

This product is ENERGY STAR® qualified.

### Optical

#### Photometrics:

Photometrics are based on prorated reports. Contact the RAB Lighting Design department for the most up-to-date data.

#### Optics:

80° beam spread with specular thermoplastic optics and Nanostructure lens technology for smooth light output and high efficiency.

### Electrical

#### Driver:

ELV, 0-10V and TRIAC Dimming, Constant Current, Class 2, 120V-277V, 50/60Hz, Power Factor 98%, THD ≤ 20%.

#### Dimming Driver:

0 - 10V (at 120-277V), TRIAC and ELV (at 120V only).

### LED Characteristics

#### LED:

Long-life, high-output LED module. Binned for natural white light to match incandescent and 3-step MacAdam Ellipse consistency.

#### Lifespan:

100,000-hour LED lifespan based on IES LM-80 results and TM-21 calculations.

#### Correlated Color Temp. (Nominal CCT):

3000 Warm.

#### Color Consistency:

3-step MacAdam Ellipse binning to achieve consistent fixture-to-fixture color.

#### Color Stability:

LED color temperature is warranted to shift no more than 200K in CCT over a 5 year period.

### Construction

#### Ambient Temperature:

Suitable for use in 40°C ambient temperatures.

#### Cold Weather Starting:

The minimum starting temperature is -40°C/-40°F

#### Trim Ring:

White powder coated die cast trim ring.

#### Trim Cone:

White square trim cone.

#### Lens:

Nanostructure lens eliminates "hot spots", and helps provide smooth, uniform light and higher efficiency.

#### Junction Box:

Integral junction box with wiring capacity for Min 90°C supply conductors  
2 in 2 out

#### Housing:

Professional-grade, die-cast aluminum construction.

#### Easy Installation:

Easy installation with ceiling clamps.

#### Green Technology:

Mercury and UV free. RoHS compliant components. Polyester powder coat finish formulated without the use of VOC or toxic heavy metals.

### Other

#### Equivalency:

RDLED 20W is equivalent to 100W PAR.

#### Air Tight:

Housing certified Air Tight as per ASTM E283

#### Absolute White™:

A unique binning process designed to match incandescent at each color temperature. It's 3-step consistent, very stable over time and looks the way you expect light to look.

#### California Title 24:

RDLED6S20 complies with 2013 California Title 24 building and electrical codes as a residential indoor fixture. It also complies as a commercial indoor fixture for general spaces when used with a vacancy sensor and TRIAC dimming control. Select a vacancy sensor using catalog number LVS800. TRIAC dimmer provided by others.

#### Warranty:

RAB warrants that our LED products will be free from defects in materials and workmanship for a period of five (5) years from the date of delivery to the end user, including coverage of light output, color stability, driver performance and fixture finish.

#### Country of Origin:

Designed by RAB in New Jersey and assembled in the USA by RAB's IBEW Local 3 workers.

## Technical Specifications (continued)

### Other

#### Buy American Act Compliant:

This product is a COTS item manufactured in the United States, and is compliant with the Buy American Act.

#### Recovery Act (ARRA) Compliant:

This product complies with the 52.225-21 "Required Use of American Iron, Steel, and Manufactured Goods-- Buy American Act-- Construction Materials (October 2010).

#### Trade Agreements Act Compliant:

This product is a COTS item manufactured in the United States, and is compliant with the Trade Agreements Act.

#### GSA Schedule:

Suitable in accordance with FAR Subpart 25.4.

## Dimensions

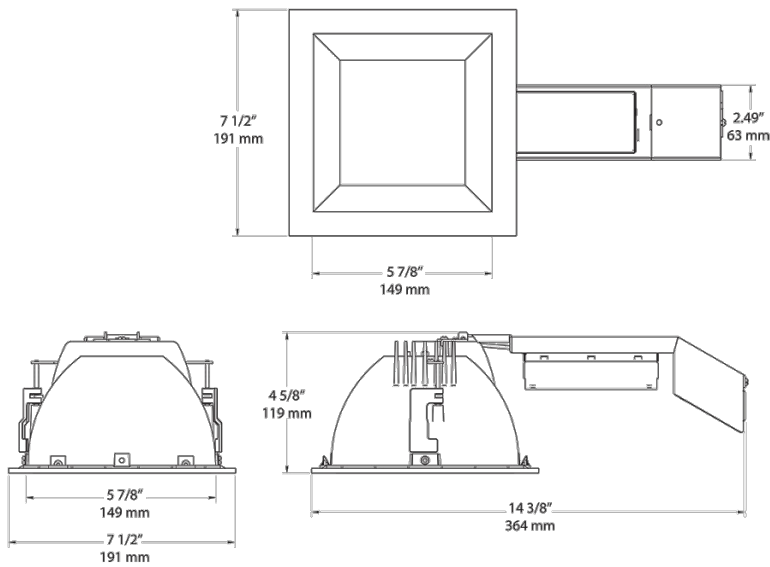

## Features

- High performance, high efficiency alternative to incandescent lighting
- Integrated ceiling clamps make installation fast and secure for ceiling up to 1 1/4" thick
- Nanostructure lens eliminates "hot spots" providing smooth and efficient light
- Low-profile design allows for installation in ceilings with limited space
- Absolute White™ natural light output

## Ordering Matrix

Family	Size	Shape	Watts	Driver Option	Beam Spread	Color Temp	CRI	Cone Color	Trim Color
RDLED	6 = 6"	S = Square	12 = 12W (4" only)	D = Universal Dimming	50 = 50°	YY = 2700K (Residential Warm)	Blank = 82 CRI	W = White	W = White
	4 = 4"		20 = 20W		80 = 80°	Y = 3000K (Warm)	HC = 92 CRI		
			26 = 26W (6" only)		W = Wall Washer	YN = 3500K (Warm Neutral)			