



The two-foot SHARK is available in 18W and 25W versions. This impact-resistant linear LED washdown fixture is ideal for car washes, tunnels, stairwells and other hard-to-reach areas where relamping is difficult and costly. 0-10V dimming models available.

Color: White

Weight: 7.5 lbs

Project:	Type:
Prepared By:	Date:

Driver Info		LED Info	
Type:	Constant Current	Watts:	18W
120V:	0.16A	Color Temp:	4000K
208V:	0.09A	Color Accuracy:	73 CRI
240V:	0.08A	L70 Lifespan:	100000
277V:	0.07A	Lumens:	2,179
Input Watts:	19W	Efficacy:	114 LPW
Efficiency:	94%		

Technical Specifications

Listings

UL Listing:

Marine Listed Outside Type (Saltwater). Listed according to UL1598A.

NEMA Rating:

4X, protected against corrosion

IESNA LM-79 & LM-80 Testing:

RAB LED luminaires have been tested by an independent laboratory in accordance with IESNA LM-79 and LM-80, and have received the Department of Energy "Lighting Facts" label.

Electrical

Driver:

Class 2 Constant Current, 4kV, 100-277VAC, 50-60Hz

Dimming Driver:

Driver includes dimming control wiring for 0-10V dimming systems. Requires separate 0-10V DC dimming circuit. Dims as low as 10%.

THD:

7.2% at 120V, 7.8% at 277V

Power Factor:

98.5% at 120V, 94.5% at 277V

Construction

IP Rating:

Ingress Protection rating of IP66 for dust and water

Reflector/Tray:

Aluminum

Housing:

5VA impact-resistant polycarbonate with stainless steel door clips. 1/2" openings for conduit and bushing/cord entry.

Mounting:

Quick-mount, surface, stainless steel spring clips supplied. 4 additional mounting accessory kits available.

Lens:

Textured, diffuse polycarbonate lens for low glare and maximum protection

Gaskets:

EVA silicone foam

Maximum Ambient Temperature:

Suitable for use in 104°F (40°C) ambient temperatures

Cold Weather Starting:

The minimum starting temperature is -40°C/-40°F

Green Technology:

Mercury and UV free. RoHS compliant components. Polyester powder coat finish formulated without the use of VOC or toxic heavy metals.

Finish:

Our environmentally friendly polyester powder coatings are formulated for high-durability and long-lasting color, and contains no VOC or toxic heavy metals.

LED Characteristics

LEDs:

Long-life, high-efficiency surface mount LEDs

Lifespan:

100,000-hour LED lifespan based on IES LM-80 results and TM-21 calculations.

Color Stability:

LED color temperature is warranted to shift no more than 200K in CCT over a 5 year period

Color Uniformity:

RAB's range of CCT (Correlated Color Temperature) follows the guidelines of the American National Standard for Specifications for the Chromaticity of Solid State Lighting (SSL) Products, ANSI C78.377-2015.

Other

Warranty:

RAB warrants that our LED products will be free from defects in materials and workmanship for a period of five (5) years from the date of delivery to the end user, including coverage of light output, color stability, driver performance and fixture finish.

Country of Origin:

Designed by RAB in New Jersey and assembled in the USA by RAB's IBEW Local 3 workers.

Buy American Act Compliant:

This product is a COTS item manufactured in the United States, and is compliant with the Buy American Act.

Recovery Act (ARRA) Compliant:

This product complies with the 52.225-21 "Required Use of American Iron, Steel, and Manufactured Goods-- Buy American Act-- Construction Materials (October 2010).

GSA Schedule:

Suitable in accordance with FAR Subpart 25.4.

Technical Specifications (continued)

Other

American Bureau of Shipping (ABS) :

For use on Mobile Offshore Drilling Units (MODU) and shipping vessels.

Dimensions

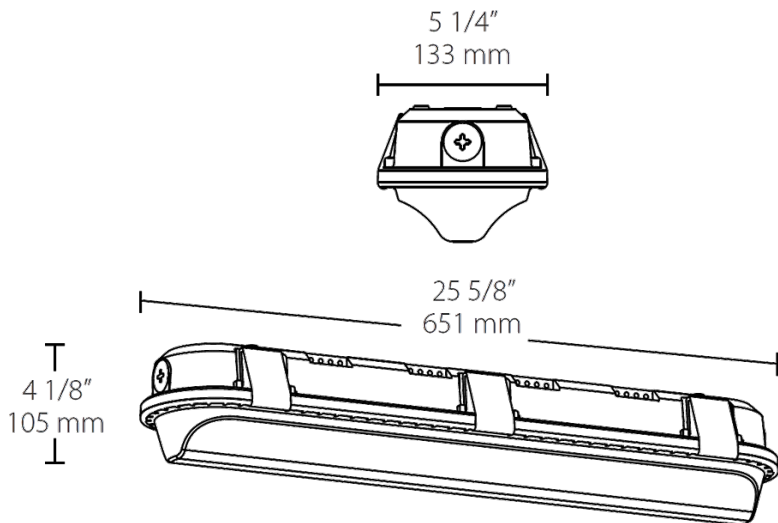

Features

UL Marine Listed

Impact-resistant linear washdown

Ideal for car washes, tunnels and stairwells

Mounting options: Chain, junction box, angled surface mount or vandal-resistant surface mount

IP66 Rating protects against dust & water ingress

5-Year, no compromise warranty

100,000-Hour LED lifespan