



37, 57 and 62 Watt SLIM Wallpacks are designed to cover the footprint of most traditional wallpacks. They are suitable for mounting heights from 20' to 30', and replace HID Wattages from 200W MH to 320W MH. These ultra-high efficiency fixtures are available in cutoff or full cutoff models.

Color: Bronze

Weight: 11.0 lbs

Project:	Type:
Prepared By:	Date:

Driver Info		LED Info	
Type:	Constant Current	Watts:	57W
120V:	0.48A	Color Temp:	3000K
208V:	0.32A	Color Accuracy:	80 CRI
240V:	0.28A	L70 Lifespan:	100000
277V:	0.24A	Lumens:	3,598
Input Watts:	57W	Efficacy:	64 LPW
Efficiency:	N/A		

Technical Specifications

Other

SLIMFC57 with Bi-Level Operation:

Allows 50% and 100% output modes.

HID Replacement Range:

The SLIMFC57 can be used to replace 250W MH based on delivered lumens.

Accessories:

Available accessories include polyshield and wire guard. Click to see all accessories.

California Title 24:

See SLIMFC57/BL for a 2013 California Title 24 compliant product. Any additional component requirements will be listed in the Title 24 section under technical specifications on the product page.

Patents:

The design of the SLIM™ is protected by patents pending in US, Canada, China, Taiwan and Mexico.

Warranty:

RAB warrants that our LED products will be free from defects in materials and workmanship for a period of five (5) years from the date of delivery to the end user, including coverage of light output, color stability, driver performance and fixture finish.

Country of Origin:

Designed by RAB in New Jersey and assembled in the USA by RAB's IBEW Local 3 workers.

Buy American Act Compliant:

This product is a COTS item manufactured in the United States, and is compliant with the Buy American Act.

Recovery Act (ARRA) Compliant:

This product complies with the 52.225-21 "Required Use of American Iron, Steel, and Manufactured Goods-- Buy American Act-- Construction Materials (October 2010).

Trade Agreements Act Compliant:

This product is a COTS item manufactured in the United States, and is compliant with the Trade Agreements Act.

GSA Schedule:

Suitable in accordance with FAR Subpart 25.4.

Listings

UL Listing:

Suitable for wet locations. Wall Mount only.

Dark Sky Approved:

The International Dark Sky Association has approved this product as a full cutoff, fully shielded luminaire.

IESNA LM-79 & LM-80 Testing:

RAB LED luminaires have been tested by an independent laboratory in accordance with IESNA LM-79 and LM-80, and have received the Department of Energy "Lighting Facts" label.

Construction

Footprint:

Designed to replace RAB HID WP2 wallpacks, both in size and footprint template, so upgrading to LED is easy and seamless.

IP Rating:

Ingress Protection rating of IP66 for dust and water.

Cold Weather Starting:

The minimum starting temperature is -40°C/-40°F

Maximum Ambient Temperature:

Suitable for use in 40°C (104°F) ambient temperatures

Thermal Management:

Superior thermal management with internal Air-Flow fins.

Housing:

Precision die-cast aluminum housing and door frame.

Mounting:

Die-cast back box with four (4) conduit entry points and knockout pattern for junction box or direct wall mounting. Hinged housing and bubble level for easy installation.

Full Cutoff:

Full cutoff meets dark-sky requirements.

Recommended Mounting Height:

Up to 25 ft.

Lens:

Microprismatic diffusion glass lens reduces glare and has smooth and even light distribution.

Reflector:

Specular thermoplastic.

Gaskets:

The unique design of the tight-lock gasket ensures no water or environmental elements will ever get inside the SLIM.

Technical Specifications (continued)

Construction

Finish:

Our environmentally friendly polyester powder coatings are formulated for high-durability and long-lasting color, and contains no VOC or toxic heavy metals.

Green Technology:

Mercury and UV free. RoHS compliant components. Polyester powder coat finish formulated without the use of VOC or toxic heavy metals.

LED Characteristics

LED:

Long-life, high-efficiency, micro-power, surface mount LEDs; binned and mixed for uniform light output and color.

Lifespan:

100,000-hour LED lifespan based on IES LM-80 results and TM-21 calculations.

Correlated Color Temp. (Nominal CCT):

3000K

Color Stability:

LED color temperature is warranted to shift no more than 200K in CCT over a 5 year period.

Color Consistency:

7-step MacAdam Ellipse binning to achieve consistent fixture-to-fixture color.

Dimensions

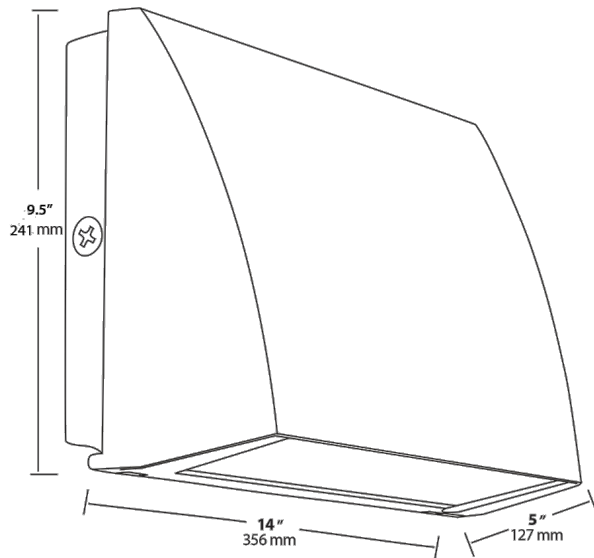

Features

- Covers footprint of most traditional wallpacks
- Easy installation with hinged access, bubble level and multiple conduit entries
- Tight-lock gasket keeps elements out
- 100,000-hour LED lifespan
- 5-Year warranty

Ordering Matrix

Family	Cutoff	Watts	Color Temp	Finish	Photocell	Bi-Level
SLIM						
	Blank = Standard C = Cutoff FC = Full Cutoff	62 = 62W 57 = 57W 37 = 37W	Blank = 5000K (Cool) Y = 3000K (Warm) N = 4000K (Neutral)	Blank = Bronze W = White	Blank = No Photocell /PC = 120V Button /PC2 = 277V Button /PCS = 120V Swivel /PCS2 = 277V Swivel	Blank = No Bi-Level /BL = Bi-Level (57W & 62W)