



11" or 15" round fixture. 35, 50, 70, 100 & 150w HPS lamp or 50, 70 & 100 Watt Metal Halide. Housing is die formed heavy gauge aluminum in bronze enamel finish with clear vandalproof polycarbonate refractor. Lamps supplied.

Color: N/A

Weight: 8.3 lbs

Project:	Type:
Prepared By:	Date:

Lamp Info		Ballast Info	
Type:	ED17	Type:	R-NPF 120V
Watts:	50W	120V:	1.8/1.2A
Shape/Size:	N/A	208V:	N/A
Base:	N/A	240V:	N/A
ANSI:	N/A	277V:	N/A
Hours:	24,000	Input Watts:	62W
Lamp Lumens:	4,000	Efficiency:	81%
Efficacy:	65 LPW		

Technical Specifications

Listings

UL Listing:

Suitable for wet locations. Fixtures can be wired with 90°C supply wiring if supply wires are routed 3" away from ballast.

Electrical

Sockets:

HPS & MH Medium base 4kv Pulse Rated Glazed porcelain CFL Plug-in type, thermoplastic.

Optical

Refractor:

Injection molded polycarbonate, designed for maximum structural strength.

Construction

Screws:

Tamperproof center pin Torx-head and slotted Phillips head stainless steel screws provided. Be sure to order your Torx screwdriver (Catalog # VANDRIVER).

Reflectors / Backplate:

Heavy gauge cold rolled steel with high reflectance baked white enamel.

Fluorescent Ballast Starting Temperatures:

Electronic QT 0°F/-18°C NPF 120V 32°F / 0°C.

Other

Country of Origin:

Designed by RAB in New Jersey and assembled in the USA by RAB's IBEW Local 3 workers.

Buy American Act Compliant:

This product is a COTS item manufactured in the United States, and is compliant with the Buy American Act.

Recovery Act (ARRA) Compliant:

This product complies with the 52.225-21 "Required Use of American Iron, Steel, and Manufactured Goods-- Buy American Act-- Construction Materials (October 2010).

Trade Agreements Act Compliant:

This product is a COTS item manufactured in the United States, and is compliant with the Trade Agreements Act.

GSA Schedule:

Suitable in accordance with FAR Subpart 25.4.

Dimensions

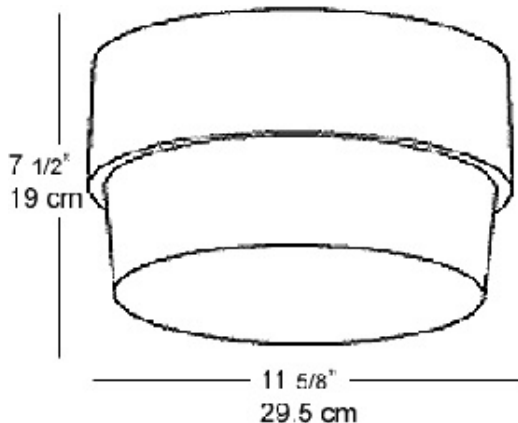

Features

- Both Vandal proof Center Pin Torx and slotted Phillips head screws supplied
- Tough polycarbonate refractors
- Backboxes available for conduit entry